

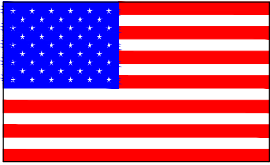

Woodbine, Iowa



Made in America

OWNER'S / OPERATOR'S MANUAL

Railgate Series BIFOLD 2500 & 3000

- Safety Information
- Warranty Information
- Operator's Instructions
- Maintenance Instructions
- Parts List

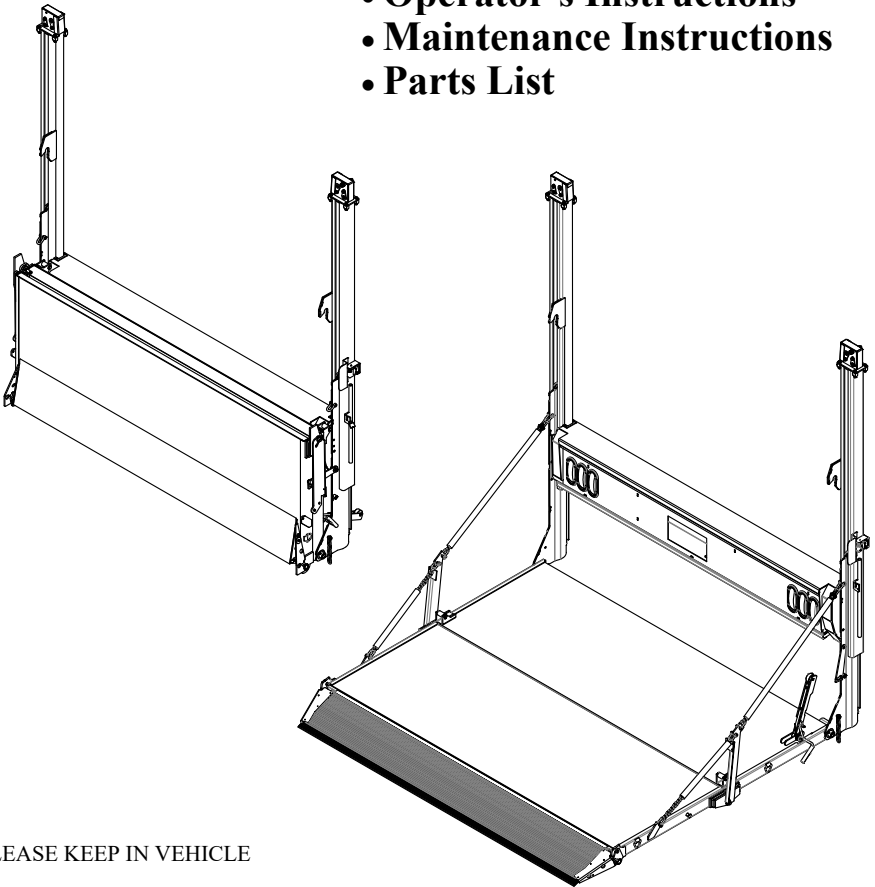

PLEASE KEEP IN VEHICLE

CAUTION

Before installing or using this liftgate, please observe the Vehicle Loading Limitations. These loading limitations are outlined in the Vehicle Owner's Manual and the Safety Compliance Certification Label located on the driver's door pillar.

CAUTION

TABLE OF CONTENTS

| | <u>Page #</u> |
|--|---------------|
| <u>Introduction</u> | |
| To the Owner/Operator. | 3 |
| <u>Safety Decals</u> | |
| Location and Descriptions. | 4 - 7 |
| Decal Replacement. | 6 |
| <u>Operator's Instructions</u> | |
| Railgate Terms and Method of Operation. | 8 |
| Self Close Operator's Instructions. | 9 & 10 |
| Dock Loading Operator's Instructions. | 11 |
| Retention Ramp Operator's Instrutions. | 12 |
| <u>Electrical Wiring Diagrams</u> | |
| Standard Fixed Control. | 13 |
| Optional Pendant Control. | 14 |
| Power Unit Control Circuit. | 15 |
| <u>Maintenance and Service</u> | 16 |
| <u>Troubleshooting</u> | 17 |
| <u>Warranty</u> | |
| Standard Warranty. | 18 |
| Warranty Claims Handling Procedure. | 19 |
| <u>Repair Parts List</u> | |
| Mainframe Repair Parts Drawing. | 20 |
| Platform Repair Parts Drawing. | 21 |
| Repair Parts Descriptions. | 22 |
| <u>Service Records</u> | 23 |
| <u>Contact Information</u> | 24 |

TO THE OWNER\OPERATOR:

Read this manual completely before using your gate. Operate and maintain your gate safely as outlined in this manual. Be sure you read and understand all operating, safety, maintenance and service information. Should you need repair or service information, contact Tommy Gate or an authorized distributor for assistance.



This is the safety alert symbol. It is used to alert you to potential personal injury hazards. Obey all safety messages that follow this symbol to avoid possible injury or death.



DANGER indicates an imminently hazardous situation which, if not avoided, will result in death or serious injury.



WARNING indicates a potentially hazardous situation which, if not avoided, could result in death or serious injury.



CAUTION indicates a potentially hazardous situation which, if not avoided, may result in minor or moderate injury.



CAUTION indicates a potentially hazardous situation which, if not avoided, may result in property damage.

Safety is a primary concern in the design and manufacture of our products. Unfortunately, our efforts to provide safe equipment can be wiped out by a single careless act of an operator.

Accident prevention and safety are dependent upon the awareness, concern, prudence and proper training of the personnel who operate, transport, maintain and store this equipment. It is your responsibility to use good judgment in the operation of this equipment.

It has been said that **"the best safety device is an informed, careful operator."** We ask you to be that kind of operator.

DECAL LOCATIONS AND DESCRIPTIONS

Refer to Figure 2 on page 7 for specific decal location.

Locate and read all decals prior to operating gate
REPLACE IF MISSING OR NOT READABLE

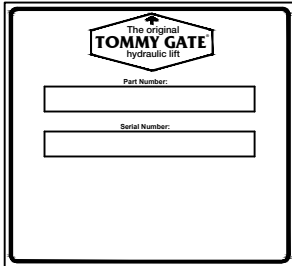

Decal No. 1 -Driver Upright and Inside Mainframe

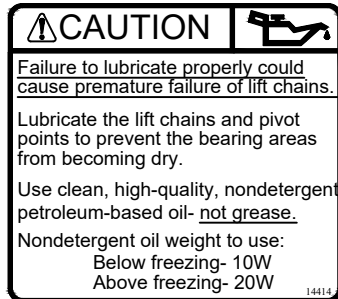

Decal No. 2 - Passenger Upright



Decal No. 3 -Passenger Upright

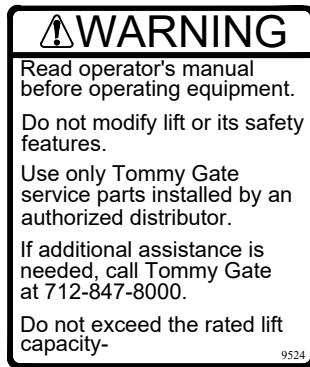

Decal No. 4 - Passenger Upright

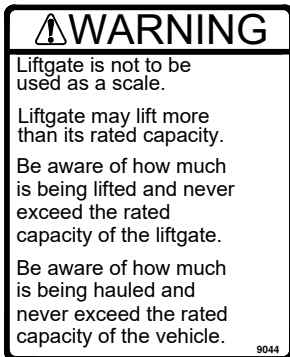

Decal No.5 - Passenger Upright

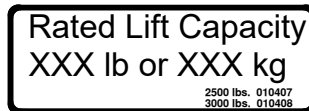

Decal No. 6 - Passenger Upright

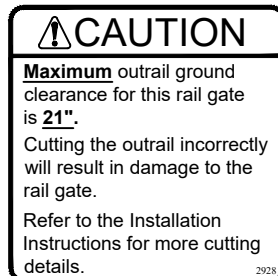

Decal No. 7 - Both Uprights

DECAL LOCATIONS AND DESCRIPTIONS

Refer to Figure 2 on page 7 for specific decal location.



Decal No. 8 - Both Uprights



Decal No. 9 - Dock/Storage Latch



Decal No. 10 - (2X) Safety Trip Bar, (6X) Platform, and (2X) Folding Arms

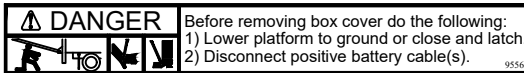

Decal No. 11 - Boxcover

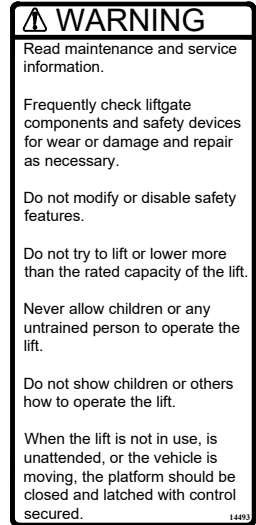

Decal No. 14 - Passenger Upright



Decal No. 12 - Front of Safety Trip Bar and Back of Mainframe

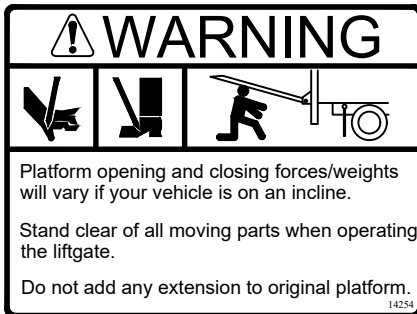

Decal No. 13 - Retention Ramp

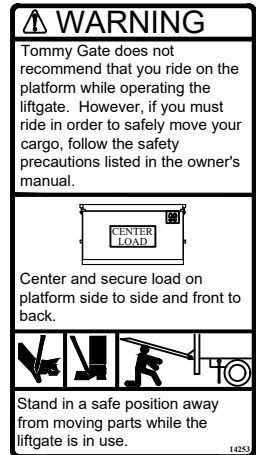

Decal No. 15 - Platform

DECAL LOCATIONS AND DESCRIPTIONS

Refer to Figure 2 on page 7 for specific decal location.



Decal No. 16 - (4X) Platform



Decal No. 17 - Retention Ramp



Decal No. 18 - Retention Ramp

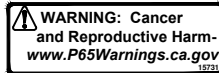

Decal No. 19
Passenger Upright

DECAL REPLACEMENT

NOTE: When ordering Decals, please have Decal Numbers available.

To replace decal, clear area of grease and dirt with non-flammable solvent and soap and water. Allow to dry. To apply decal, peel off 1/2 of back. Hold decal squarely and apply to cleaned surface. Peel off remaining back and smooth in place. Gently rub decal with a damp rag or sponge to smooth out bubbles. (The decal has a pressure-sensitive adhesive on the back.)

If the liftgate **is** going to be painted, you need to mask the decals before painting. Remove the mask **after** painting so the decals can be read clearly.

RAILGATE TERMS AND METHOD OF OPERATION

The terms used to describe parts of the railgate in this manual can be found in Figure 3.

Your Tommy Gate is connected to your vehicle battery. The vehicle battery powers a motor, coupled to a hydraulic pump. This motor and pump combination is called a power unit. Flow from the pump extends a cylinder to provide tension to the lift chains that lift the gate platform. A pressure relief valve prevents the gate from being overloaded. A check valve blocks return flow from the cylinder to the pump. The gate platform is lowered by gravity after the "lower" solenoid valves are activated and opened at the pump and cylinder.

!Warning: Liftgate is not to be used as a scale. Liftgate may lift more than its rated capacity. Be aware of how much is being lifted and never exceed the rated capacity of the liftgate. Be aware of how much is being hauled and never exceed the rated capacity of the vehicle.

Two safety switches are mounted above the safety trip bar. These two switches interrupt power from the "raise" solenoid and direct the power to the "lower" solenoid valves if an obstruction raises the safety trip bar.

A "Low Voltage" condition exists when 7 Volts or less is present at the power unit. A low voltage condition should be corrected as soon as possible. In a "Low Voltage" situation, whether the gate actually raises or lowers depends on how low the voltage is.

Caution: Continuing to operate the the liftgate in the "Low Voltage" condition may result in failure of electrical components in the power unit.

The low voltage condition may be caused by a weak battery, loose or corroded connections, improper ground, or bad electrical cables. This condition may be corrected by just starting the vehicle or replacing the battery.

!Caution:

**Never leave the truck with the platform on the ground, partially raised, or open.
Never show children or unauthorized personnel how to operate the gate.**

To prevent children or unauthorized personnel from operating the lift, be sure the gate is in the stored position and both the driver's side and passenger's side latches are secured. Make sure the passenger's side padlock is installed and the control is deactivated before leaving the truck unattended.

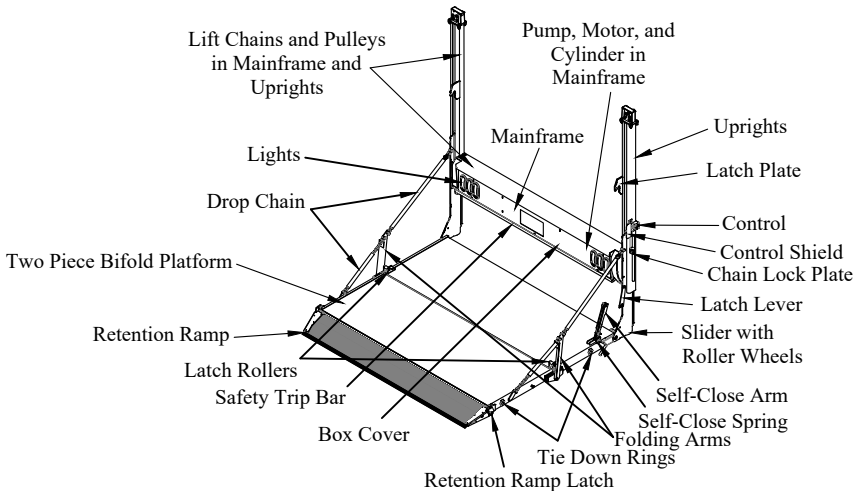

Figure 3: Railgate Terms

RAILGATE OPERATOR'S INSTRUCTIONS

SELF-CLOSE PLATFORM

- Step 1. **Never show children or unauthorized personnel how to operate the railgate.**
- Step 2. Clear away obstructions that could damage the platform while the load is being raised or lowered.
- Step 3. Be sure to stand to the side of the lift, not behind it when opening the platform.

Step 4. To turn the control power on, press the "POWER ON" hidden switch once, marked with white rings or circles (located below the Tommy Gate logo). You should see the amber LED "POWER ON" light when the control is armed. To disarm the control press the "POWER ON" hidden switch again.

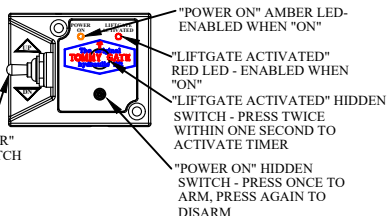

To activate the control, press the "LIFTGATE ACTIVATED" hidden switch twice within one second (located under the Tommy Gate logo). You should see the red "LIFTGATE ACTIVATED" light when the control is activated.

Figure 4: Control terms.

To lower the platform, push the control toggle switch down. To raise the platform, push the control toggle switch up. When you remove pressure from the control toggle switch, the operation will stop.

After you have activated the control by pressing the "LIFTGATE ACTIVATED" hidden switch twice within one second (located under the Tommy Gate logo), you have approximately 5 minutes to use the gate. If the gate is not used for approximately 5 minutes, the "LIFTGATE ACTIVATED" timer deactivates the control. If the gate is used during the 5 minutes, the "LIFTGATE ACTIVATED" timer automatically resets for an additional 5 minutes. To reactivate the timer, press the "LIFTGATE ACTIVATED" hidden button twice within one second.

Note: If your gate includes a pendant control, the operation of the pendant will be the same but the "LIFTGATE ACTIVATED" timer will be 90 seconds.

- Step 5. Unlock and remove the Padlock. Move the Safety Chain from the Chain Lock Plate. Put the Padlock in the same location it was removed from (Figure 5).
- Step 6. Move the Latch Lever off of the Latch Peg on the platform (Figure 6).
- Step 7. To lower the liftgate, stand off to the side, well clear of the liftgate, and push down on the control toggle. The platform will open and unfold as the liftgate is lowered.

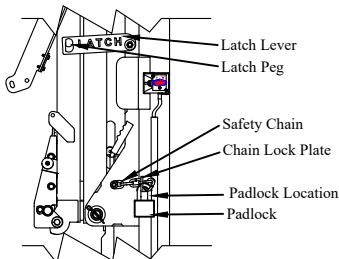

Figure 5: Step 5.

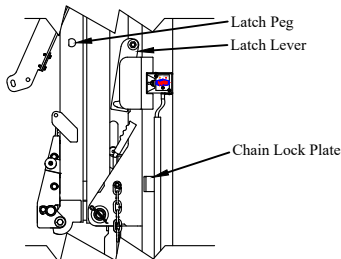

Figure 6: Step 6.

RAILGATE OPERATOR'S INSTRUCTIONS

SELF-CLOSE PLATFORM

- Step 8. Allow the platform self-close arm to unfold the platform to the horizontal position as it lowers. Check to make sure the self-close arm has returned to the disengaged position (Figure 7).
- Step 9. To load and use the railgate, center the load on the platform side to side and front to back (Figure 8). Put heavier loads as close to the front of the platform as possible (near truck). Tie Down Rings are provided for securing the load. Retention Ramp may be moved to Vertical or Loading Position at this time.
- Note:** Railgate capacity depends on both the weight and location of the load. Loads placed closer to the taper may reduce lifting capacity or damage the liftgate.

⚠ WARNING

Tommy Gate does not recommend that you ride on the platform while operating the liftgate. However, if you must ride in order to safely move your cargo, follow these safety precautions.

- A. Inspect the liftgate prior to use. Do not operate if unsafe conditions exist.
- B. Always secure load in a safe manner to prevent shifting of the load. Center and secure load on platform side to side and front to back.
- C. To avoid overloading the liftgate, derate the capacity by the weight of the operator.
- D. Stand in the area indicated by the footprints in the figure below (Figure 8), keeping hands and feet away from the edges and any moving parts.
- E. Use only a pendant control or a control mounted on the inside of the outrail or truck to operate the lift while standing on the platform.

- Step 10. To raise (or lower) the load, push up (or down) on the control toggle switch until the load has reached the desired position. **Be sure the self-close arm is disengaged.** Do not allow the pump and motor to continue to run after the platform has reached its maximum height or after it has reached an obstruction (Figure 9).

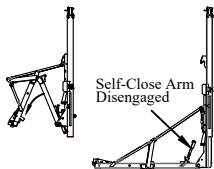

Figure 7: Step 8.

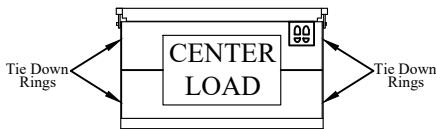

Figure 8: Step 9.

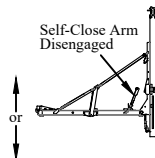

Figure 9: Step 10.

- Step 11. To close the platform, stand to the passenger's side of the platform, not under or behind the platform. With the platform lowered, move the retention ramp to the travel position, then lift the handle of the self-close arm with your hand to engage the self-close arm (Figure 10).
- Step 12. Continue holding the self-close arm in the engaged position while raising the platform. After the platform begins to fold, release the handle of the self-close arm and step away from the lift. Continue raising the platform until the platform latch rollers drive up into the latch plates (Figure 11).
- Step 13. Hook the Latch Lever securely back onto the Latch Peg on the platform (Figure 11).
- Step 14. Place the loose end of the Safety Chain in the slot on the Chain Lock Plate (Figure 12).
- Step 15. Always install the Padlock and deactivate the control when not in use (Figure 12).

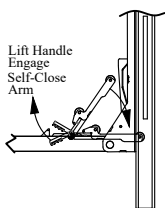

Figure 10: Step 11.

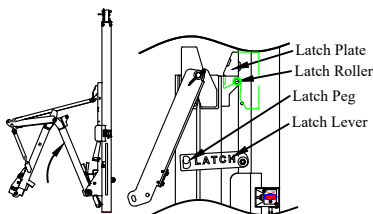

Figure 11: Step 12 & 13.

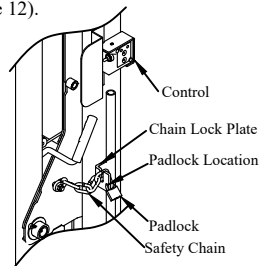

Figure 12: Steps 14 & 15.

RAILGATE OPERATOR'S INSTRUCTIONS

DOCK LOADING

Transferring from Travel/Storage Position to Dock Loading Position.

- Step 1. Unlock and remove the Padlock. Move the Safety Chain from the Chain Lock Plate. Put the Padlock in the same location it was removed from (Figure 13).
- Step 2. Verify that the Latch Lever is securely hooked on the Latch Peg on the platform (Figure 13).
- Step 3. Activate the control.
- Step 4. To lower the liftgate, stand off to the side, well clear of the liftgate, and push down on the control toggle. The platform will remain vertical while lowering into the dock saddles (Figure 14).

⚠ WARNING

Do Not drive the vehicle* with the gate in the dock loading position. The platform must be returned to the travel position. Failure to do this may cause damage to the liftgate and/or vehicle.

*On level ground free of obstructions, it is permissible to move the vehicle for dock loading as necessary.

Transferring from Dock Loading Position to Travel/Storage Position.

- Step 5. Verify that the Latch Lever is securely hooked on the Latch Peg on the platform (Figure 13).
- Step 6. Raise the platform until the platform Latch Rollers drive up into the Latch Plates (Figure 13).
- Step 7. Place the loose end of the Safety Chain in the slot on the Chain Lock Plate (Figure 13).
- Step 8. Always install the Padlock and deactivate the control when not in use (Figure 13).

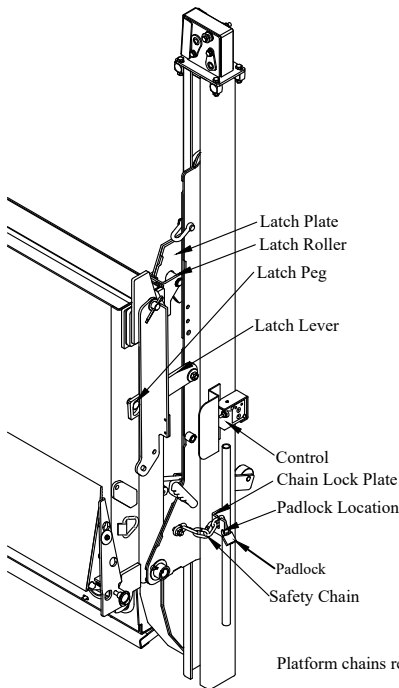

Figure 13: Storage/Travel Position.

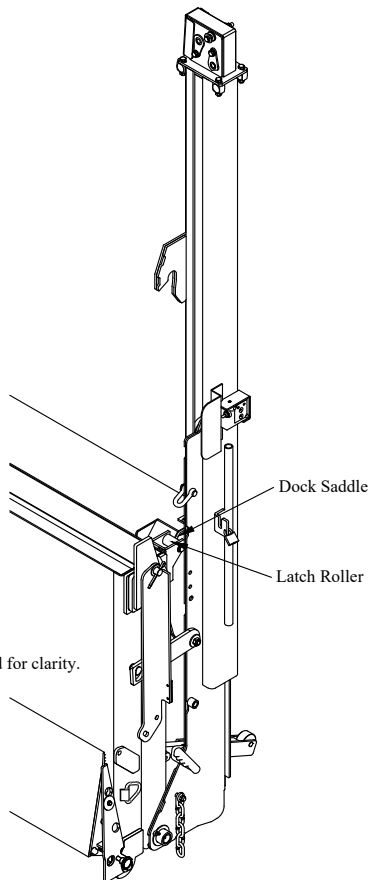
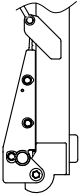

Figure 14: Dock Loading Position.

RETENTION RAMP OPERATOR'S INSTRUCTIONS

Retention Ramp in Approved Operational Positions.



Platform and ramp both in the Travel Position.

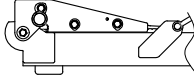

Platform open with ramp in the Travel Position.

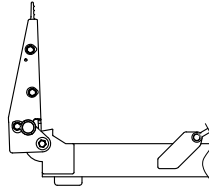

Platform open with ramp in the Vertical Position.

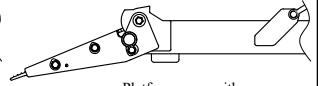

Platform open with ramp in the Loading Position.

Travel Position

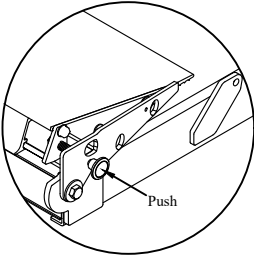

Push Retention Ramp Latch in to unlock from the Travel Position.

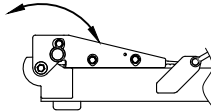

Rotate ramp to position desired.

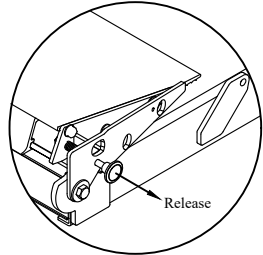

Release Retention Ramp Latch to lock in the Travel Position.

Vertical Position

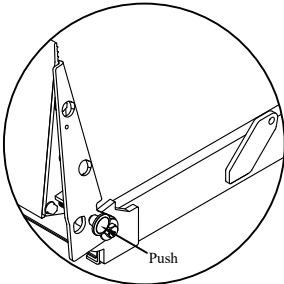

Push Retention Ramp Latch in to unlock from Vertical Position.

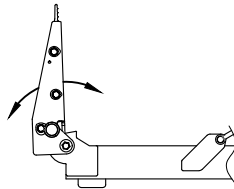

Rotate ramp to desired position

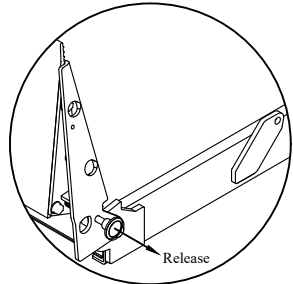

Release Retention Ramp Latch to lock in Vertical Position.

Loading Position

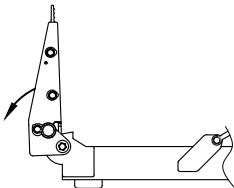

Once the ramp is unlocked from Vertical Position and rotated downward, it is free moving.

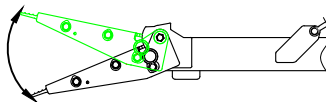

The ramp will rotate freely to ensure contact with the ground.

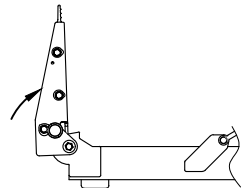

The Retention Ramp Latch will not lock until it is returned to the Vertical Position.



ELECTRICAL WIRING DIAGRAM

Optional Pendant Control - Railgate

!!! PLEASE READ AND FOLLOW ALL DIRECTIONS BEFORE PROCEEDING !!!



NOTE !!! IF GATES ARE NOT WIRED IN ACCORDANCE WITH THIS DIAGRAM YOUR WARRANTY WILL BE VOID.



WELDING NOTE !!! DISCONNECT ALL BATTERY CABLES. ALWAYS DISCONNECT THE GROUND CABLE FIRST. ATTACH THE WELDING GROUND TO THE TRUCK RATHER THAN THE LIFTGATE.

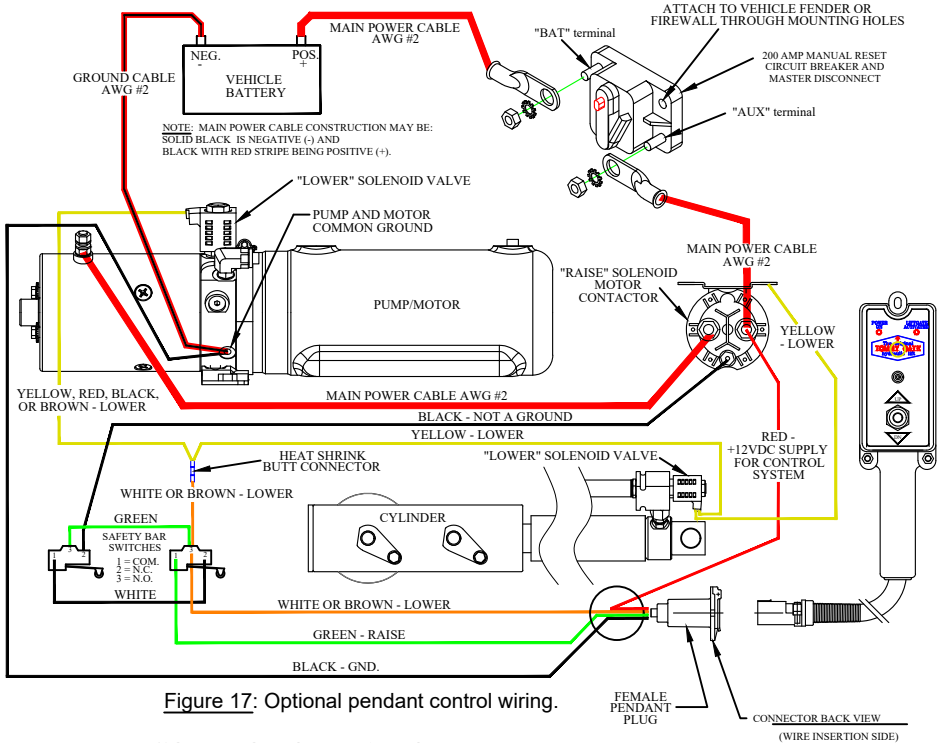
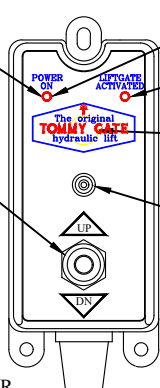

Figure 17: Optional pendant control wiring.

CONTROL OPERATION

BLINKING AMBER LED INDICATES LOW VOLTAGE CONDITION



"POWER ON" AMBER LED-ENABLED WHEN "ON"

"LIFTGATE ACTIVATED" RED LED - ENABLED WHEN "ON"

"LIFTGATE ACTIVATED" HIDDEN SWITCH - PRESS TWICE WITHIN ONE SECOND TO ACTIVATE TIMER

"POWER ON" HIDDEN SWITCH - PRESS ONCE TO ARM, PRESS AGAIN TO DISARM.

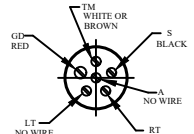











| POSITION | WIRE COLOR |
|----------|----------------|
| S | BLACK |
| RT | GREEN |
| LT | NO WIRE |
| TM | WHITE OR BROWN |
| A | NO WIRE |
| GD | RED |

Figure 18: Control operation.

NOTE: THIS CONTROL HAS A 90 SECOND TIMER.

POWER UNIT CONTROL CIRCUIT

| Legend | |
|---|--|
|  | Circuit Breaker |
|  | Limit Switch |
|  | Contactor - Normally Open Contacts |
|  | Motor |
|  | Solenoid/Contactor - Coil |
|  | Battery Cable |
|  | Wire |
|  | Grounded through motor chassis. |
|  | Grounded through liftgate chassis and motor chassis. |
|  | Eyelet Terminal |
|  | Splice |

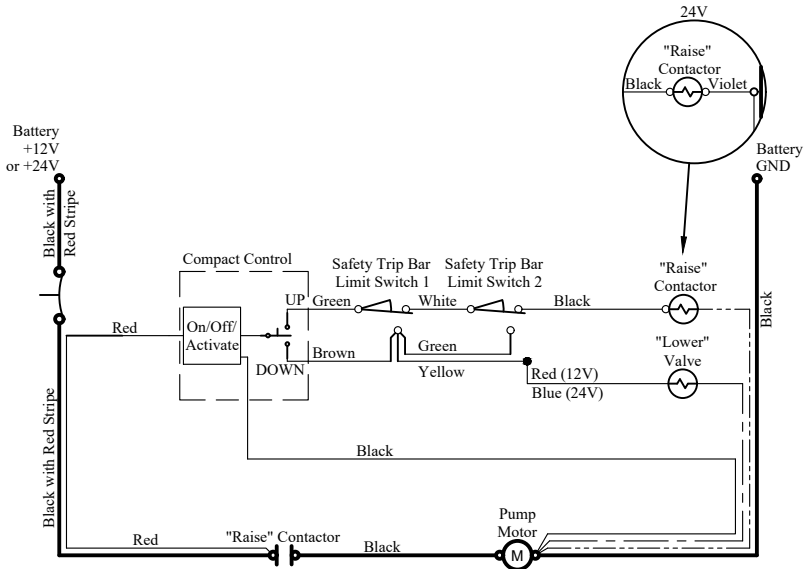

MAINTENANCE AND SERVICE INFORMATION

The terms used to describe parts of the railgate in this manual can be found in Figures 1-3.

The Tommy Railgate needs to be serviced every 120 days or 4000 cycles, whichever comes first.

The lift will not be automatically serviced when the vehicle is serviced.

If there is any noticeable problem with the liftgate between service intervals, the liftgate must be taken out of service and checked immediately.

As is with any mechanical product, a preventive maintenance program needs to be followed in order to keep it in its best operating condition. Please review this information and if you should have any questions please call (712) 847-8000. Please have your model number and serial number available.

All installations, re-installations, and repairs of Tommy Gate Railgates should be performed by a qualified authorized distributor that is familiar with its operation and safety features. All replacement parts must be of original quality, and all safety and operational decals must be attached. No modifications are allowed to a Tommy Gate product unless authorized by the Engineering Department at Tommy Gate.

MAINTENANCE PROCEDURE

- (A) Remove the box cover.
- (B) Check for fluid leaks from the cylinder, hoses, and all fittings (replace or repair if found to be leaking).
- (C) Check the oil level in the reservoir. With the liftgate platform at the bottom of its travel, the fluid should be two-thirds full. Add Tommy Gate winter grade, ISO grade 32 hydraulic, or Dexron III/ Mercon ATF if needed.
- (D) Check the inside of the box for excessive accumulation of dirt. Clean as necessary.
- (E) Check the lift chains, the platform drop chains, the platform, the uprights, the vertical sliders, and the pulleys for damage or excessive wear. Replace any worn or damaged part.

NOTE: If no issues are found during the 120 day inspections, we recommend that the lift chains be replaced after 4 years or 10,000 cycles whichever comes first. Chains should be replaced with original "Tommy Gate" chain only.

- (F) Clean the inside surfaces of the uprights with a nonflammable solvent. Lubricate the lift chains and pivot points with clean, high quality, nondetergent, petroleum-based oil- **DO NOT USE GREASE.** Use nondetergent 10W @ (14°F-32°F), 20W @ (32°F-104°F), and 30W @ (104°F-122°F).
- (G) Check the welds on the railgate, its mounting brackets and on the adjacent vehicle structure for cracks or damage. Repair any cracks or damage.
- (H) Check the torque on all mounting bolts and re-tighten as necessary.

TROUBLESHOOTING - 2500 & 3000 RAILGATE SERIES

| PROBLEM | POSSIBLE CAUSE | REMEDIES |
|--|---|--|
| 1.) Lift will not operate - "POWER ON" amber LED light does not come on. | a.) Control not armed properly. b.) Poor electrical connection. c.) 3 Amp mini - ATO fuse is blown. d.) Polarity is reversed. e.) Circuit breaker tripped or disengaged. f.) Faulty control. | a.) Turn the power on at the control by pressing the "POWER ON" hidden switch, marked with white rings or circles (located between the Tommy Gate logo and the toggle switch). b.) Check and repair or replace all cables and connections. c.) Correct short and then replace fuse. d.) Switch positive and negative cables. e.) Check for short, then manually engage circuit breaker. f.) Replace Control. |
| 2.) Lift will not operate - "LIFTGATE ACTIVATED" red LED light does not come on. | a.) "POWER ON" amber LED light is blinking. b.) Control not activated properly. c.) Faulty control. | a.) Low voltage condition. Check and repair or replace all cables and connections. b.) Press the "LIFTGATE ACTIVATED" hidden switch twice within one second (located under the Tommy Gate logo). The red "LIFTGATE ACTIVATED" LED light should come on. c.) Replace control. |
| 3.) Lift will not operate - "POWER ON" amber LED light shuts off during operation. | a.) Less than 4 Volts at Power Unit. b.) Poor grounds or connections. c.) Power connected or reconnected since last use. | a.) Check and clean or repair all electrical connections. Load test battery, then recharge or replace battery, if required. Reset control. b.) Repair, replace, clean as necessary. c.) Normal, press bulls-eye once to activate solid "POWER ON" amber LED. |
| 4.) Lift will not raise or raises slowly - control working properly. | a.) Poor electrical connection. b.) Battery charge is low. c.) "Lower" valve stuck partially open or dirty. d.) "Lower" valve needs replacement. e.) "Raise" solenoid not working. f.) Safety bar switch bent- Holding "lower" valve open. g.) Oil level low. h.) Vent plug not installed or dirty. i.) Overloaded liftgate. j.) Lifting chains improperly adjusted. | a.) Check power and ground cables and all connections. b.) Recharge or replace battery. c.) Raise platform completely and continue to run pump for 5 seconds. d,e,f.) Contact Tommy Gate or distributor. g.) Check oil and add ISO grade 32, Tommy Gate winter grade hydraulic, or Dexron III/Mercon ATF. h.) Check vent plug on pump tank. A red shipping plug is installed at factory. It must be replaced by the metal vented plug. i.) Remove some material or weight. j.) Adjust Lifting chains. |
| 5.) Lift settles down slowly with load or no load. | a.) Hoses or fittings leaking. b.) Check valve stuck or dirty. c.) Check valve damaged. d.) Cylinder seals worn or damaged. e.) "Lower" solenoid sticking partially open. | a.) Tighten or replace. b.) Raise and lower lift several times to flush out valve. c,d,e.) Contact Tommy Gate or distributor for repair or replacement. |
| 6.) Pump or motor noisy. | a.) Worn pump, motor or coupling. b.) Oil level low | a.) Contact Tommy Gate or distributor. b.) Check oil and add ISO grade 32, Tommy Gate winter grade hydraulic, or Dexron III/Mercon ATF. |
| 7.) Lift lowers very slowly, especially in cold weather. | a.) Cold, thick, oil. b.) Rollers sticking in uprights. | a.) Check oil type. Add winter grade Tommy Gate hydraulic or Dexron III/Mercon ATF. b.) Clean Rollers and Lubricate with nondetergent oil. |
| 8.) Lift will not lower. | a.) Control not armed and activated - No amber "POWER ON" LED or red "LIFTGATE ACTIVATED" LED light on. b.) Poor electrical connections. c.) 3 Amp Mini - ATO fuse is blown. d.) Rollers stuck in uprights. e.) If control working properly, damaged or non-working "lower" solenoid. | a.) Press the "POWER ON" hidden switch, marked with white rings or circles (located between the Tommy Gate logo and the toggle switch). The amber "POWER ON" LED light should come on. Now press the hidden "LIFTGATE ACTIVATED" switch twice within one second (located under the Tommy Gate logo). The red "LIFTGATE ACTIVATED" LED light should come on. b.) Check and clean or repair all electrical connections. c.) Correct short and then replace fuse. d.) Clean items wedged between rollers and rail. e.) Contact Tommy Gate or distributor. |
| 9.) Gate does not lower smoothly. | a.) Lift chains need to be adjusted. b.) Installer has left a burr at bottom of uprights. c.) Load has been put off to one side of platform. d.) Platform drop chains improperly adjusted. | a.) Adjust lift chains so platform is level with top of mainframe on both driver's and passenger's side. b.) Raise and close platform, grind or file off burr from outrail. c.) Center load on the platform. d.) Adjust platform drop chains. |
| 10.) Gate lowers when trying to raise. | a.) Safety trip bar damaged. b.) Safety switch bent or stuck open. | a.) Straighten or replace safety bar. b.) Check switches for free movement up and down. |



STANDARD WARRANTY

Railgate Series

2500 & 3000

The Tommy Gate Company provides a limited warranty against faulty materials or workmanship.

2-Year Warranty

Tommy Gate pump and motor unit parts are guaranteed for two (2) full years from date of user purchase against faulty materials or workmanship.

2-Year Warranty

Tommy Gates are guaranteed for (2) years from the date of user purchase against faulty materials or workmanship.

All affected parts must be returned to the factory prepaid - with full credit issued for those found to be defective. Warranty replacement parts will be shipped from the factory prepaid.

Labor charges to install warranty replacement parts shall be paid in accordance with Tommy Gate's estimated repair time guide and a flat hourly rate established by Tommy Gate.

DEVIATION FROM THE WARRANTY TIMES LISTED MUST BE AUTHORIZED BY TOMMY GATE COMPANY IN ADVANCE.

The warranty does not include damage resulting from improper installation procedures. Parts must be installed according to Tommy Gate Company's specifications.

Tommy Gate Company will not pay labor for removing other equipment to gain access to Tommy Gate Equipment. Tommy Gate Company will not pay labor for time on the road to and from a service call.

Tommy Gate Company reserves the right to disallow or reduce claims for parts which have been damaged due to misuse, abuse, accidents, improper shipping; or parts which have been incorrectly or unnecessarily replaced.

The warranty is void if the product has been subject to other than normal use. **THERE ARE NO WARRANTIES, EXPRESS OR IMPLIED, INCLUDING THE WARRANTY OF MERCHANTABILITY OR A WARRANTY OF FITNESS FOR A PARTICULAR PURPOSE EXTENDING BEYOND THAT SET FORTH ABOVE.**

NOTE: SEE FOLLOWING PAGE FOR THE WARRANTY CLAIMS HANDLING PROCEDURE.



WARRANTY CLAIMS HANDLING PROCEDURE

The following procedures are required when an authorized distributor submits a warranty claim for a defective Tommy Gate part:

1. Before any expense is incurred, but after the problem has been diagnosed, the authorized distributor should contact Tommy Gate Company's Warranty Department to discuss the problem and its correction.
2. If it is determined that the condition is potentially covered by Tommy Gate Company's warranty, the authorized distributor will receive instructions on how to proceed. A decision will be made to either repair or replace the product or part in question.
3. If the product or parts are to be repaired, the authorized distributor will receive a **WARRANTY REQUEST NUMBER**.
4. If the product or parts are to be replaced, the authorized distributor will be instructed to either hold the parts for inspection by a representative, in which case the authorized distributor will receive a **WARRANTY REQUEST NUMBER**, or the authorized distributor will be asked to return the product for inspection to Tommy Gate Company, in which case the authorized distributor will receive a **RETURN GOODS AUTHORIZATION NUMBER**. Under no circumstances are parts to be returned without a **RETURN GOODS AUTHORIZATION NUMBER**.
5. After the repair or replacement work is completed, the authorized distributor will submit the claim to Tommy Gate Company with the following information.
 - a. Tommy Gate Company **WARRANTY REQUEST** and/or **RETURN GOODS AUTHORIZATION NUMBER**.
 - b. Tommy Gate model number.
 - c. Tommy Gate serial number.
 - d. Tommy Gate part number involved and a description of the apparent problem or defect.
 - e. Authorized distributor performing warranty work.
 - f. Person responsible for warranty work (contact).
 - g. Distributor from whom liftgate was purchased.
 - h. Liftgate owner's name, address, and phone number.
 - i. Action taken, cost involved, complete with work orders and parts expense invoices.
6. If defective parts are to be returned to Tommy Gate Company they:
 - a. Must be packaged for each individual warranty return. No multiple warranty claims in the same box.
 - b. Must be returned "freight prepaid" to Tommy Gate Company's location.
 - c. Must be clearly marked with the **RETURN GOODS AUTHORIZATION NUMBER** on the outside of the package.

Warranty claims must be submitted by the Authorized Distributor on behalf of their customer as part of their customer assistance.

Warranty claim acceptance or rejection is based solely upon defective part inspection and a review of the claim date (outlined in step 5 above) as they apply to the requirements of Tommy Gate Warranty. Claim reimbursement after acceptance is governed by those allowances previously agreed upon between Tommy Gate Company and the Authorized Distributor (as outlined in Steps 1-4 above).

Any warranty claims submitted without a **WARRANTY REQUEST NUMBER** or **RETURN GOODS AUTHORIZATION NUMBER** and the necessary information will be denied.

2500 AND 3000 RAILGATE SERIES REPAIR PARTS DRAWING

FOR MODELS 89 & 95
(WITH INTERNAL TIMED ELECTRIC TOGGLE CONTROL)

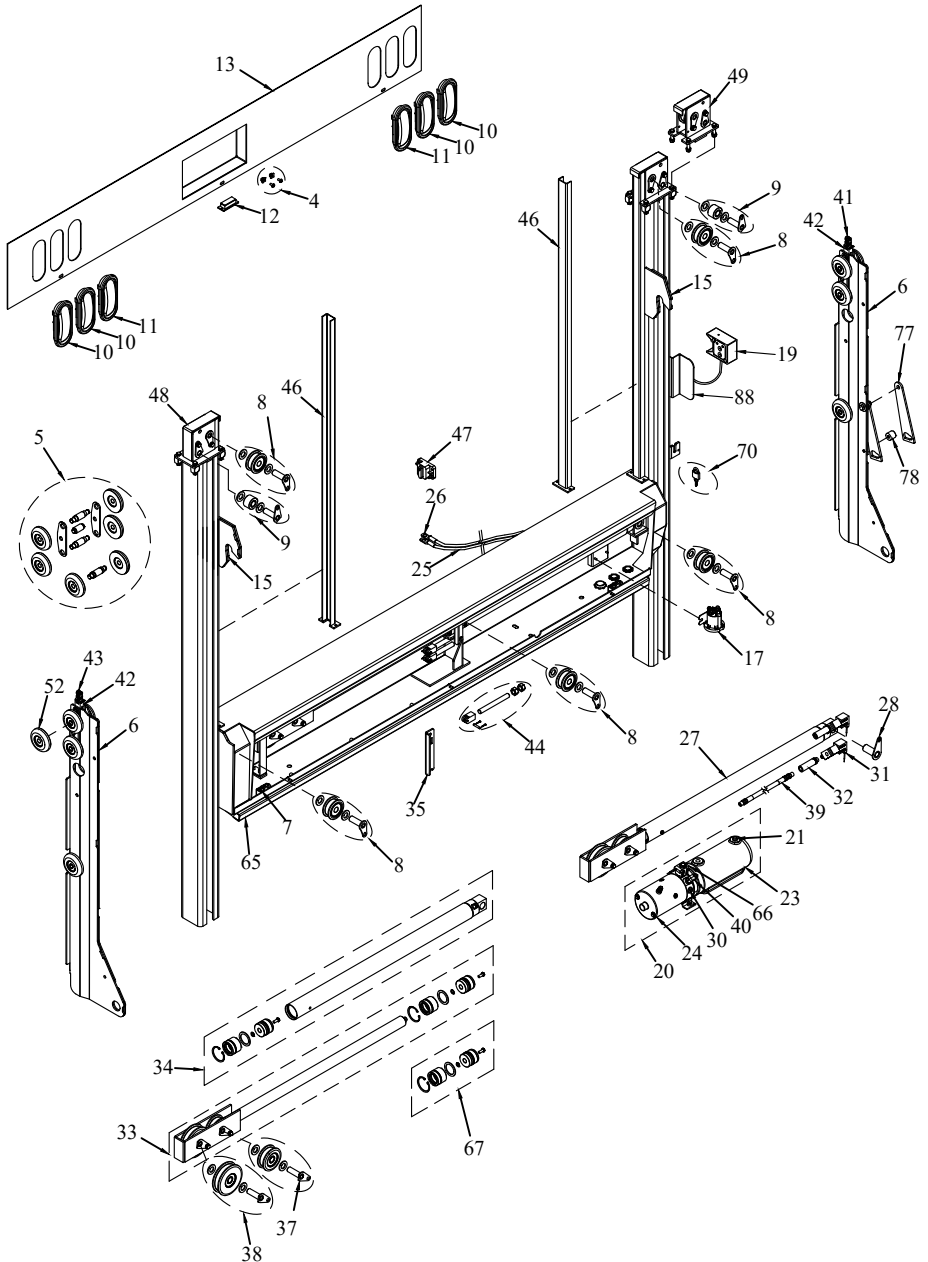

2500 AND 3000 RAILGATE SERIES STEEL PLATFORM WITH RETENTION RAMP REPAIR PARTS DRAWING

FOR MODELS 89 & 95
(WITH INTERNAL TIMED ELECTRIC TOGGLE CONTROL)

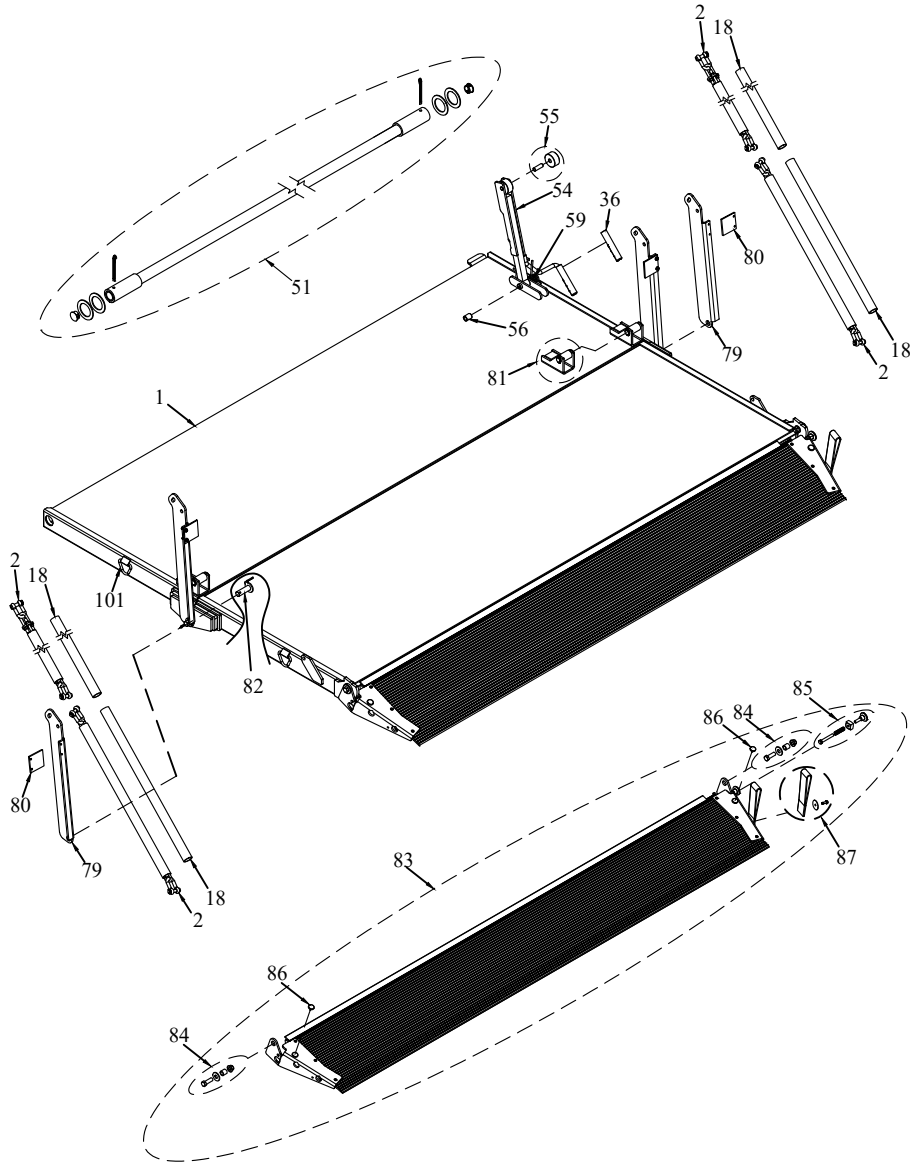

2500 AND 3000 RAILGATE SERIES REPAIR PARTS LIST

FOR MODELS 89 & 95

(WITH INTERNAL TIMED ELECTRIC TOGGLE CONTROL)

| ITEM# | DESCRIPTION | ITEM# | DESCRIPTION |
|-------|--------------------------------------|-------|--------------------------------------|
| 1 | Platform | 39 | Hydraulic Hose |
| 2 | Platform Chains | 40 | 90 Degree Pump Elbow |
| 4 | License Plate Mount Kit | 41 | Leaf Chain - Passenger's Side |
| 5 | Roller Kit (for one complete slider) | 42 | Leaf Chain Attachment Fitting |
| 6 | Slider with Roller Wheels | 43 | Leaf Chain - Driver's Side |
| 7 | Safety Switch | 44 | Adjustment Screw, Clevis & Pin |
| 8 | 3" Pulley | 46 | Leaf Chain Cover |
| 9 | 1.75" Idler Pulley | 47 | 200 Amp Manual Reset Circuit Breaker |
| 10 | Red Light | 48 | Upright Cap - Left |
| 11 | Clear Light | 49 | Upright Cap - Right |
| 12 | License Plate Light | 51 | Hinge Tube |
| 13 | Box Cover w/Lights | 52 | Roller Assembly (individual roller) |
| 15 | Latch Plate | 54 | Self-Close Arm |
| 17 | "Raise" Solenoid | 55 | Self-Close Arm Roller |
| 18 | Cloth Chain Cover | 56 | Self-Close Arm Bushing |
| 19 | Timed Control | 59 | Self-Close Arm Spring |
| 20 | Pump & Motor | 65 | Safety Trip Bar |
| 21 | Vent Plug | 66 | "Lower" Solenoid |
| 23 | Tank Only | 67 | Cylinder Repair Kit |
| 24 | Motor Only | 70 | Latch Padlock |
| 25 | 2ga. 2 Wire Electric Cable | 77 | Dock/Storage Latch |
| 26 | Copper Lug | 78 | Dock/Storage Latch Rest |
| 27 | Cylinder | 79 | Folding Arm |
| 28 | Cylinder Pin | 80 | Folding Arm Rubber Belting |
| 30 | Lee Check Valve | 81 | Latch Roller Kit |
| 31 | Cylinder "Lower" Solenoid Assembly | 82 | Folding Pivot Pin |
| 32 | Flow Control | 83 | Retention Ramp Kit |
| 33 | Cylinder Shaft | 84 | Retention Ramp Pivot Kit |
| 34 | Cylinder Barrel | 85 | Retention Ramp Latch Kit |
| 35 | Cylinder Clamp | 86 | Retention Ramp Rubber Bumpers |
| 36 | Self-close Rubber Handle | 87 | Handle Strap |
| 37 | 3.5" Pulley | 88 | CTC Mounting Bracket and Shield Kit |
| 38 | 4.75" Pulley | 101 | Tie Down Ring |

Note:

The item number **is not** the part number. Please have the model number and serial number available before calling for repair parts.



**America's First Name
in liftgates™**

Manufacturing Plant:
83 Bus Brown Drive
Woodbine, Iowa 51579
FAX (712) 647-2417

Corporate Offices:
33717 N. Scottsdale Rd. Ste 120
Scottsdale, AZ 85266
FAX (602) 955-3902

(712) 847-8000
www.tommygate.com

