

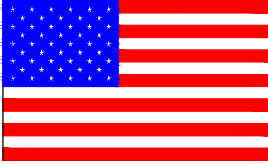

Woodbine, Iowa



Made in America

OWNER'S / OPERATOR'S MANUAL

- Safety Information
- Warranty Information
- Operator's Instructions
- Maintenance Instructions
- Parts List



650 Series
650 LB Capacity



CAUTION

Before installing or using this Lift Gate, please observe the Vehicle Loading Limitations. These loading limitations are outlined in the Vehicle Owner's Manual and the Safety Compliance Certification Label located on the driver's door pillar.



CAUTION

PLEASE KEEP IN VEHICLE

Page 1 of 20



TABLE OF CONTENTS

<u>Introduction</u>	<u>Page#</u>
To the Owner\Operator	3
 <u>Safety Decals</u>	
Location and Descriptions	4 & 5
Decal Replacement	5
 <u>Operator's Instructions</u>	
Series 650 Terms and Method of Operation	6
Operator's Instructions	7 & 8
Swing Release Latch Operation	9
 <u>Electrical Wiring Diagrams</u>	
Standard Pendant Control	10
Ladder Logic/Wiring Diagram	11
<u>Maintenance and Service</u>	12
<u>Troubleshooting</u>	13 & 14
 <u>Warranty</u>	
Standard Warranty	15
Warranty Claims Handling Procedure	15 & 16
 <u>Repair Parts List</u>	
Repair Parts Drawing	17
Repair Parts List	18
 <u>Service Records</u>	19
 <u>Contact Information</u>	20

TO THE OWNER\OPERATOR

Read this manual completely before using your gate. Operate and maintain your gate safely as outlined in this manual. Be sure you read and understand all operating, safety, maintenance and service information. Should you need repair or service information, contact Tommy Gate or an authorized distributor for assistance.



This is the safety alert symbol. It is used to alert you to potential personal injury hazards. Obey all safety messages that follow this symbol to avoid possible injury or death.



DANGER indicates an imminently hazardous situation which, if not avoided, will result in death or serious injury.



WARNING indicates a potentially hazardous situation which, if not avoided, could result in death or serious injury.



CAUTION indicates a potentially hazardous situation which, if not avoided, may result in minor or moderate injury.

Safety is a primary concern in the design and manufacture of our products. Unfortunately, our efforts to provide safe equipment can be wiped out by a single careless act of an operator.

Accident prevention and safety are dependent upon the awareness, concern, prudence and proper training of the personnel who operate, transport, maintain and store this equipment. It is your responsibility to use good judgment in the operation of this equipment.

It has been said that "**the best safety device is an informed, careful operator.**" We ask you to be that kind of operator.



DECAL LOCATIONS AND DESCRIPTIONS

Locate and read all decals prior to operating gate
REPLACE IF MISSING OR NOT READABLE

TOMMY GATE®

<p>DO'S</p> <ul style="list-style-type: none"> * DO CENTER YOUR LOAD ON PLATFORM. * DO CLOSE AND LOCK LIFT IN CLOSED POSITION WHEN NOT IN USE OR UNATTENDED. * DO STAND TO THE SIDE OF LIFTGATE WHILE IT IS IN OPERATION. * DO READ MAINTENANCE AND SERVICE INFORMATION. * DO READ OPERATOR'S INSTRUCTIONS. * DO FREQUENTLY CHECK CABLES CHAINS, AND OTHER COMPONENTS FOR WEAR OR DAMAGE AND REPAIR AS NECESSARY WITH PARTS PROVIDED BY THE ORIGINAL EQUIPMENT MANUFACTURER. * DO CHECK ALL SAFETY DEVICES FOR PROPER OPERATION . 	<p>DO NOT'S</p> <ul style="list-style-type: none"> * DO NOT RIDE OR PERMIT ANYONE TO RIDE ON LIFT. THE LIFT IS NOT A PERSONNEL OR WHEELCHAIR LIFT. * DO NOT MAKE ANY MODIFICATIONS TO THE LIFT OR ITS SAFETY FEATURES. * DO NOT ALLOW USE OF LIFT BY A PERSON WHO HAS NOT HAD PROPER TRAINING IN ITS OPERATION. * DO NOT TRY TO LIFT OR LOWER MORE THAN THE RATED CAPACITY OF THE LIFT. * DO NOT ADD TO OR REMOVE PARTS OF LIFT AS IT WILL VOID YOUR WARRANTY. * DO NOT MOVE VEHICLE UNLESS GATE IS IN LATCHED POSITION. * DO NOT SHOW CHILDREN OR UNAUTHORIZED PERSONNEL HOW TO OPERATE LIFT. * DO NOT LEAVE PLATFORM OPEN, OR UNLATCHED WHEN LIFT IS NOT IN USE OR UNATTENDED. NEVER LEAVE PLATFORM DOWN TO BE USED AS A STEP.
---	---

ALL REPAIRS OR REINSTALLATIONS OF TOMMY GATE LIFTS SHOULD BE PERFORMED BY AN AUTHORIZED DISTRIBUTOR THAT IS FAMILIAR WITH ITS OPERATION AND SAFETY FEATURES. ALL REPLACEMENT PARTS MUST BE OF ORIGINAL QUALITY, AND ALL SAFETY AND OPERATIONAL DECALS MUST BE ATTACHED AND LEGIBLE

9561

Decal No. 1

Place in cab in a highly visible area.

⚠ WARNING

--	--	--

Keep one hand on the platform when opening and closing.

Platform opening and closing forces/weights will vary if your vehicle is on an incline.

Stand clear of all moving parts when opening, raising or lowering platform.

Never leave the platform down to be used as a step.

Do not add any extension to original platform.

9523

Decal No. 2

Located near the top on folded platform.

⚠ WARNING

Read operator's manual before operating equipment.

Do not modify lift or its safety features.

Use only Tommy Gate service parts installed by an authorized distributor.

If additional assistance is needed, call Tommy Gate at 712-847-8000.

Do not exceed the rated lift capacity-

9524

Decal No. 3

Located on the side of the control and on the vertical lift tube

⚠ DANGER

--	--	--

Keep away from moving parts

9555

Decal No. 4

Located on three sides of the vertical lift tube and on both of the platform sides.

Rated Lift Capacity
650 lb or 300 kg

9476

Decal No. 5

Located on the side of the control and on the vertical lift tube

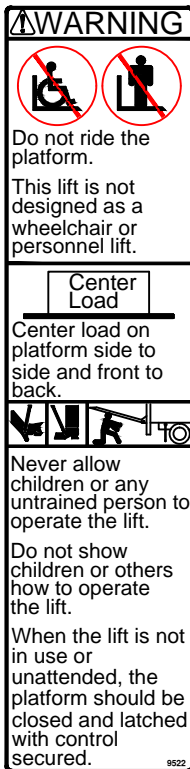

Decal No. 6
Located on the vertical lift tube.

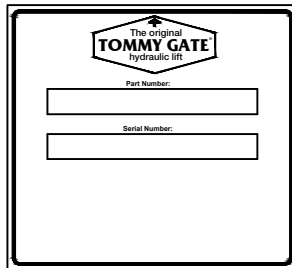

Decal No. 7
Located on vertical support tube.
(Between tubes)



Decal No. 8
Located on the torsion spring plate.

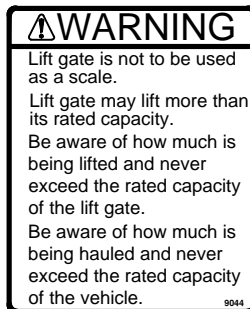

Decal No. 9
Located on the vertical lift tube.

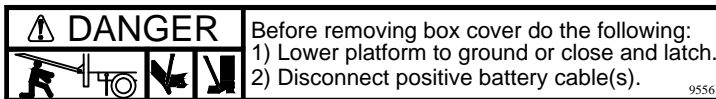

Decal No. 10
Located on box cover of pump.

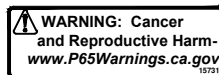

Decal No. 11
Located on the side of the control.

DECAL REPLACEMENT

NOTE: When ordering Decals, please have Decal Numbers available.

To replace decal, clear area of grease and dirt with nonflammable solvent and soap and water. Allow to dry. To apply decal, peel off 1/2 of back. Hold decal squarely and apply to cleaned surface. Peel off remaining back and smooth in place. Gently rub decal with a damp rag or sponge to smooth out bubbles. (The decal has a pressure sensitive adhesive on the back.)

If the liftgate is going to be painted, you need to mask the decals before painting. Remove the mask after painting so the decals can be read clearly.



Series 650 Terms and Method of Operation

Your Tommy Gate is connected to your vehicle battery. The vehicle battery powers a motor, coupled to a hydraulic pump. This motor and pump combination is called a power unit. Flow from the pump will compress a cylinder to lift the platform. The platform (after it is folded) is pivoted to the transport position by hydraulic force. The lift may swing 90 degrees for storage or vehicle access by releasing the swing release pin. The platform is unfolded and lowered by gravity after an electric "release" valve is activated and opened at the power unit.

!Warning: Lift gate is not to be used as a scale. Lift gate may lift more than its rated capacity. Be aware of how much is being lifted and never exceed the rated capacity of the lift gate. Be aware of how much is being hauled and never exceed the rated capacity of the vehicle.

Tommy Gate's control incorporates a "Low Voltage" warning feature. A "Low Voltage" condition exists when the "Power On" button is armed and 7 Volts or less is present at the power unit. This "Low Voltage" feature is designed to warn the operator that there is a low voltage condition and that it should be corrected as soon as possible. The amber "Power On" LED will blink to warn the operator of this condition. When this light is blinking, it will not prevent the control from functioning to raise or lower the gate. In a "Low Voltage" situation, whether the gate actually raises or lowers depends on how low the voltage is.

Caution: Continuing to operate the the lift gate in the low voltage condition may result in failure of electrical components in the power unit.

The low voltage condition may be caused by a weak battery, loose or corroded connections, improper ground, or bad electrical cables. This condition may be corrected by just starting the vehicle or replacing the battery.

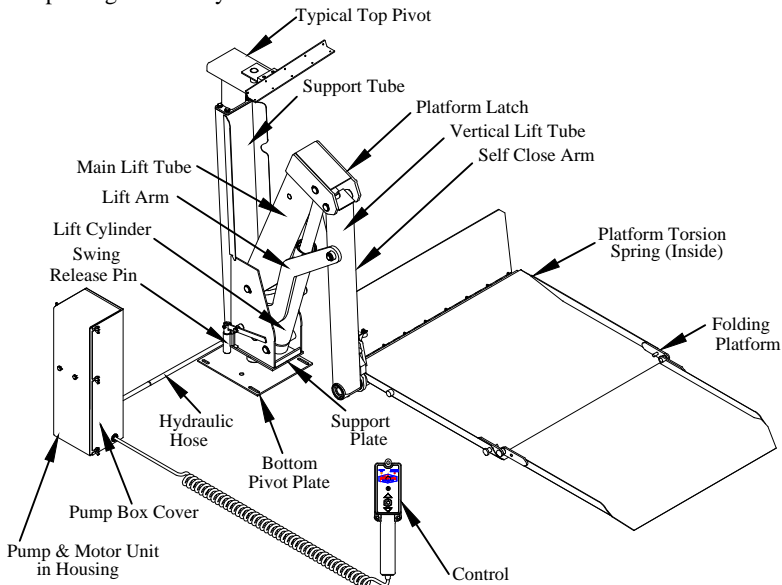



OPERATOR'S INSTRUCTIONS

- Step 1.** Never show children or unauthorized personnel how to operate the gate.
- Step 2.** Open the rear doors of the vehicle.
- Step 3.** Be sure to stand clear of the platform and all moving parts when using the lift.
- Step 4.** To turn the control power on, press the "POWER ON" hidden switch, marked with black rings or circles (located between the Tommy Gate logo and the toggle switch). You should see the amber LED "POWER ON" light when the control is armed. To disarm the control press the "POWER ON" hidden switch again.

To activate the control, press the "LIFTGATE ACTIVATED" hidden switch twice within one second (located under the Tommy Gate logo). You should see the red "LIFTGATE ACTIVATED" light when the control is activated.

To lower the platform, push the toggle switch down. To raise the platform, push the toggle switch up. When you remove pressure from the toggle switch, the operation will stop.

After you have activated the control by pressing the "LIFTGATE ACTIVATED" hidden switch twice within one second (located under the Tommy Gate logo), you have approximately 90 seconds to use the gate. If the gate is not used for approximately 90 seconds, the "LIFTGATE ACTIVATED" timer deactivates the control. If the gate is used during the 90 seconds, the "LIFTGATE ACTIVATED" timer automatically resets for an additional 90 seconds. To reactivate the timer, press the "LIFTGATE ACTIVATED" hidden button twice within one second.

- Step 5.** To lower the platform, release the latch on the left side of the platform and step to the side. When you push the toggle switch down on the control, the platform should pivot out of the van. When the platform has reached the horizontal position, unfold the platform manually to the full length position. Push the toggle switch down to lower the platform to the ground.

OPERATOR'S INSTRUCTIONS

- Step 6.** When raising the load to the vehicle bed level, stand clear of movement of the load, the platform and other moving parts.
- Step 7.** To store the lift, raise the platform to the vehicle bed level and manually fold the flipper. Push the toggle switch up to use the lift hydraulic system to pivot the platform into the stored position. Manually push the platform fully closed and latch the transport latch on the left side of the platform.
- Step 8.** To provide more room inside of the van or to load items with a fork truck, release the swing lock by pushing downwards on the lever located on the left side of the base plate. The lift and the platform may then be swung 90° inside of the vehicle and locked in position with the platform along the inside wall instead of along the rear doors of the vehicle.
- Step 9.** **Never leave the truck unattended with the platform on the ground, partially raised, or open.** To prevent children or unauthorized personnel from operating the lift, be sure the gate is in the stored position and latched. The vehicle doors should be closed and locked before leaving the truck unattended.
- Step 10.** The Tommy Gate is designed for material handling only and is not to be used as a personnel or wheelchair lift. Do not ride on the platform and always stand clear of the platform when opening, raising, or lowering.

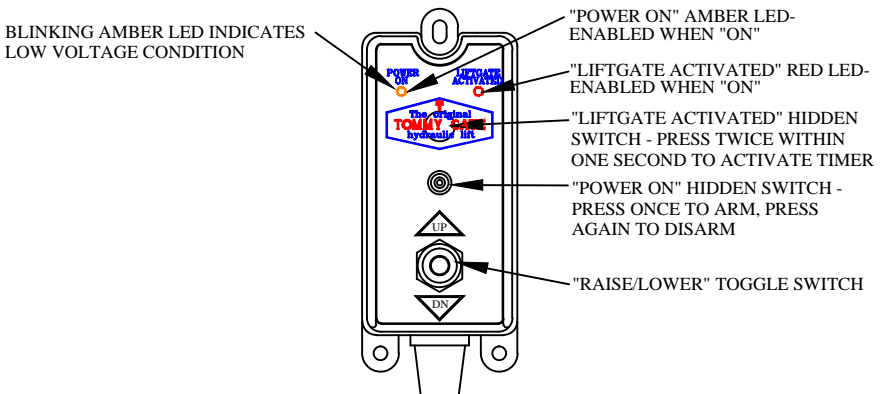

SWING RELEASE LATCH OPERATION

Swing Release
Lever

Swing Release
Pin

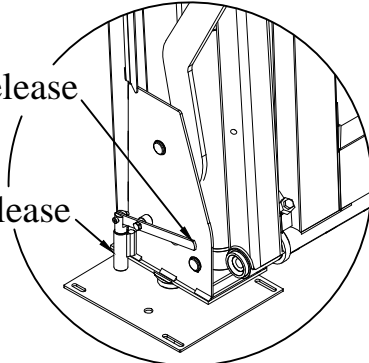

Figure 1
Swing Release Latch Assembly

Position the gate parallel with the sidewall of the vehicle.

(Not available for some vans)

- Step 1. Push down and hold the swing release lever releasing the swing release pin. (Figure 3)
- Step 2. Rotate the gate 90° to parallel with the inside wall of the vehicle. (Figure 4)
- Step 3. Release the swing release lever allowing the swing release pin to lock into the base plate. (Figure 2)
- Step 4. Verify that the latch is properly engaged and that the gate cannot rotate. (Figure 2)

Position the gate parallel with the rear door of the vehicle.

- Step 1. Push down and hold the swing release lever releasing the swing release pin. (Figure 3)
- Step 2. Rotate the gate 90° to parallel with the rear door of the vehicle. (Figure 5)
- Step 3. Release the swing release lever allowing the swing release pin to lock into the base plate. (Figure 2)
- Step 4. Verify that the latch is properly engaged and that the gate cannot rotate. (Figure 2)

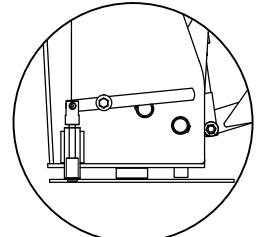

Figure 2
Latch Engaged

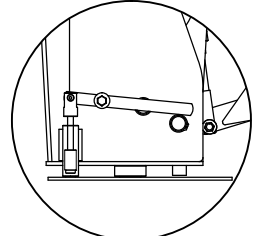

Figure 3
Latch Disengaged

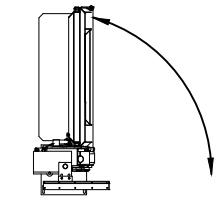

Figure 4
Gate Parallel with Inside Wall

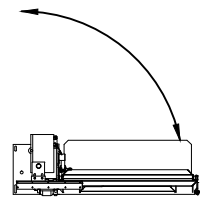

Figure 5
Gate Parallel with Rear Doors

ELECTRICAL WIRING DIAGRAM

Standard Pendant Control-Series 650

!!! PLEASE READ AND FOLLOW ALL DIRECTIONS BEFORE PROCEEDING !!!



NOTE !!! IF GATES ARE NOT WIRED IN ACCORDANCE WITH THIS DIAGRAM YOUR WARRANTY WILL BE VOID.





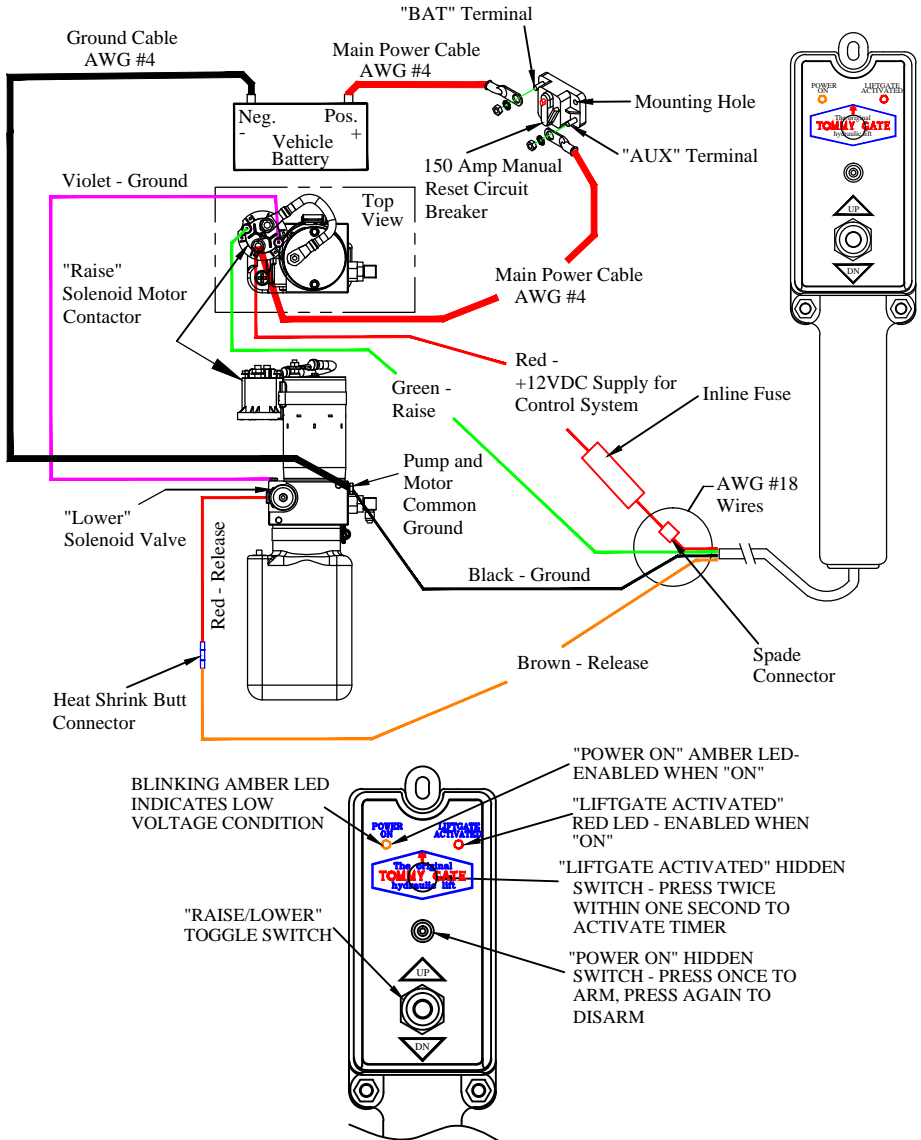







WELDING NOTE !!! DISCONNECT ALL BATTERY CABLES. ALWAYS DISCONNECT THE GROUND CABLE FIRST. ATTACH THE WELDING GROUND TO THE TRUCK RATHER THAN THE LIFTGATE.



LADDER LOGIC/WIRING DIAGRAM

Ladder Logic/Wiring Diagram

Legend	
	Circuit Breaker
	Contactor - Normally Open Contacts
	Motor
	Solenoid/Contactor - Coil
	Battery Cable
	Wire
	Grounded through motor chassis.
	Quick Disconnect
	Eyelet Terminal
	Splice
	Fuse

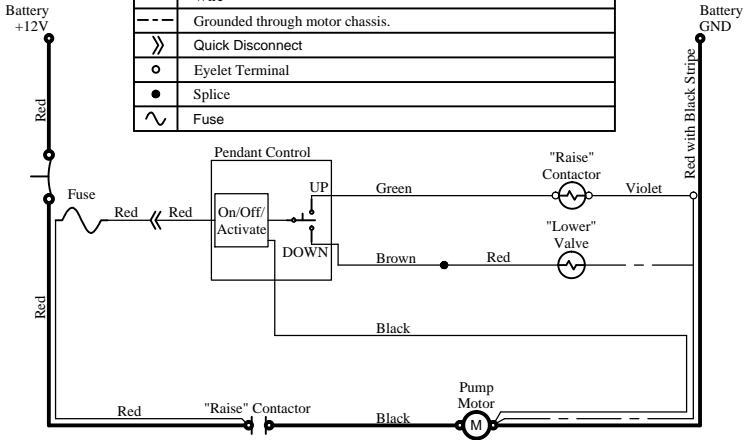



MAINTENANCE AND SERVICE INFORMATION

All installations, reinstallations, and repairs of Tommy Gates should be performed by a qualified, authorized distributor that is familiar with its operation and safety features. All replacement parts must be of original quality, and all safety and operational decals must be attached. No modifications are allowed to a Tommy Gate product unless authorized by the Engineering Department at Tommy Gate.

As is with any mechanical product, a preventative maintenance program needs to be followed in order to keep the gate in its best operating condition. Please review this information and if you should have any questions, please call 712-847-8000 . Please have your model number and serial number available.

The Tommy Gate needs to be serviced every 120 days or 1500-2000 cycles, whichever comes first.

- (A) Check the oil level in the reservoir. With the liftgate platform at the bottom of its travel, the fluid should be two-thirds full. **BE SURE THE CYLINDER IS COMPLETELY COLLAPSED.** Add Tommy Gate winter grade, ISO grade 32 hydraulic oil, Dexron or equivalent, if needed.
- (B) Check for leaks from the cylinder, hoses, and all fittings (replace or repair if found to be leaking).
- (C) Check for cracks in all welds (repair if needed).
- (D) Replace any worn or missing parts before the liftgate is put back into service.
- (E) If needed, replace the platform latch which is designed to hold the liftgate in a properly stored position.
- (F) Check for wear at all pivot points. Check for loose bolts or connectors.
- (G) Check the function of the relief valve and self-closing mechanism. The platform should self-close when the flipper is folded. The platform should not self-close when the flipper is not folded.
- (H) Check all electrical connections (clean or repair if needed).
- (I) Replace fuses, if required. Check electric cables for worn or damaged insulation.
- (J) Replace or clean safety decals so they are legible.
- (K) Check for proper operation of control.



TROUBLESHOOTING - SERIES 650

PROBLEM	POSSIBLE CAUSE	REMEDIES
1.) Lift will not operate-"POWER ON" amber LED light does not come on.	Control not armed properly.	Turn the power on at the control by pressing the "POWER ON" hidden switch, marked with black rings or circles (located between the Tommy Gate logo and the toggle switch).
	Poor electrical connection.	Check and repair or replace all cables and connections.
	Polarity is reversed.	Switch positive and negative cables.
	Circuit breaker tripped or disengaged.	Check for short, then manually engage circuit breaker.
	Faulty control.	Replace control.
2.) Lift will not operate-"LIFTGATE ACTIVATED" red LED light does not come on.	"POWER ON" amber LED light is blinking.	Low voltage condition. Check and repair or replace all cables and connections.
	Control not activated properly.	Press the "LIFTGATE ACTIVATED" hidden switch twice within one second (located under the Tommy Gate logo). The red "LIFTGATE ACTIVATED" LED light should come on.
	Faulty control.	Replace control.
3.) Blinking amber "POWER ON" LED.	Low voltage condition.	Check and clean or repair all electrical connections. Load test battery, then recharge or replace battery, if required. Reset control.
	Poor grounds or connections.	Repair, replace, clean as necessary.
	Power connected or reconnected since last use.	Normal, press bullseye once to activate solid "POWER ON" Amber LED.
4.) Lift will not raise or raises slowly -control working properly.	Poor electrical connection.	Check power and ground cables and all connections.
	Battery charge is low.	Recharge or replace battery.
	Release valve stuck, partially open or dirty.	Raise platform completely and continue to run pump for 5 seconds.
	Release valve needs replacement.	Contact Tommy Gate or distributor.
	"Raise" solenoid not working.	Contact Tommy Gate or distributor.
	Oil level low.	Check oil and add Tommy Gate winter grade, ISO grade 32 hydraulic oil, Dexon or equivalent.
	Vent plug not installed or dirty.	Check vent plug on pump tank. A red shipping plug is installed at the factory. It must be replaced by the metal vented plug.
	Overloaded liftgate.	Remove some material or weight.



TROUBLESHOOTING - SERIES 650

PROBLEM	POSSIBLE CAUSE	REMEDIES
5.) Lift settles down slowly with load or no load.	Hoses or fittings leaking.	Tighten or replace.
	Check valve stuck or dirty.	Raise and lower lift several times to flush out valve.
	Check valve damaged.	Contact Tommy Gate or distributor.
	Cylinder seals worn or damaged.	Contact Tommy Gate or distributor.
	Down solenoid sticking partially open	Contact Tommy Gate or distributor.
6.) Pump or motor noisy.	Worn pump, motor or coupling.	Contact Tommy Gate or distributor.
	Oil level low.	Check oil and add Tommy Gate winter grade, ISO grade 32 hydraulic oil, Dexron or equivalent.
7.) Lift lowers very slowly, especially in cold weather.	Cold, thick oil.	Check oil type. Add winter grade Tommy Gate hydraulic oil.
8.) Lift will not lower.	Control not armed and activated-No amber "POWER ON" LED or red "LIFTGATE ACTIVATED" LED light on.	Press the "POWER ON" hidden switch, marked with black rings or circles (located between the Tommy Gate logo and the toggle switch). The amber "POWER ON" LED light should come on. Now press the hidden "LIFTGATE ACTIVATED" switch twice within one second (located under the Tommy Gate logo). The red "LIFTGATE ACTIVATED" LED light should come on.
	Poor electrical connections.	Check and clean or repair all electrical connections.
	Lift stuck or sprung, if control is working properly.	Apply downward load on platform.
	If control is working properly, damaged or non-working release solenoid.	Contact Tommy Gate or distributor.
9.) Platform does not fold out of vehicle.	Cold, thick oil.	Check oil type. Add winter grade Tommy Gate hydraulic oil.
	Platform torsion bar broken or out of adjustment.	Contact Tommy Gate or distributor.



WARRANTY GUIDELINES

A. STANDARD WARRANTY

The Tommy Gate Company provides a limited warranty against faulty materials or workmanship. Series 650 Tommy Gates are guaranteed for one (1) year from the date of user purchase and all pump and motor unit parts are guaranteed for two (2) full years from the date of user purchase against faulty materials or workmanship.

All affected parts must be returned to the factory prepaid - with full credit issued for those found to be defective. Warranty replacement parts will be shipped from the factory prepaid.

Labor charges to install warranty replacement parts shall be paid in accordance with Tommy Gate's estimated repair time guide and a flat hourly rate established by Tommy Gate. **DEVIATION FROM THE WARRANTY TIMES LISTED MUST BE AUTHORIZED BY TOMMY GATE COMPANY IN ADVANCE.**

The warranty does not include damage resulting from improper installation procedures. Parts must be installed according to Tommy Gate Company's specifications.

Tommy Gate Company will not pay labor for removing other equipment to gain access to Tommy Gate Equipment. Tommy Gate Company will not pay labor for time on the road to and from a service call.

Tommy Gate Company reserves the right to disallow or reduce claims for parts which have been damaged due to misuse, abuse, accidents, or improper shipping; or parts which have been incorrectly or unnecessarily replaced.

The warranty is void if the product has been subject to other than normal use. **THERE ARE NO WARRANTIES, EXPRESS OR IMPLIED, INCLUDING THE WARRANTY OF MERCHANTABILITY OR A WARRANTY OF FITNESS FOR A PARTICULAR PURPOSE EXTENDING BEYOND THAT SET FORTH ABOVE.**

B. WARRANTY CLAIMS HANDLING PROCEDURE:

The following procedures are required when an authorized distributor submits a warranty claim for a defective Tommy Gate part:

1. Before any expense is incurred, but after the problem has been diagnosed, the authorized distributor should contact Tommy Gate Company's Warranty Department to discuss the problem and its correction.
2. If it is determined that the condition is potentially covered by Tommy Gate Company's warranty, the authorized distributor will receive instructions on how to proceed. A decision will be made to either repair or replace the product or part in question.
3. If the product or parts are to be repaired, the authorized distributor will receive a **WARRANTY REQUEST NUMBER.**



WARRANTY GUIDELINES

4. If the product or parts are to be replaced, the authorized distributor will be instructed to either hold the parts for inspection by a representative, in which case the authorized distributor will receive a **WARRANTY REQUEST NUMBER**, or the authorized distributor will be asked to return the product for inspection to Tommy Gate Company, in which case the authorized distributor will receive a **RETURN GOODS AUTHORIZATION NUMBER**. Under no circumstances are parts to be returned without a **RETURN GOODS AUTHORIZATION NUMBER**.
5. After the repair or replacement work is completed, the authorized distributor will submit the claim to Tommy Gate Company with the following information:
 - a. Tommy Gate Company **WARRANTY REQUEST** and/or **RETURN GOODS AUTHORIZATION NUMBER**.
 - b. Tommy Gate model number
 - c. Tommy Gate serial number
 - d. Tommy Gate part number involved and a description of the apparent problem or defect.
 - e. Authorized distributor performing warranty work.
 - f. Person responsible for warranty work (contact).
 - g. Distributor from whom lift gate was purchased.
 - h. Lift gate owner's name, address, and phone number.
 - i. Action taken and cost involved, complete with work orders and parts expense invoices.
6. If defective parts are to be returned to Tommy Gate Company, the parts:
 - a. Must be packaged for each individual warranty return. No multiple warranty claims in the same box.
 - b. Must be returned "freight prepaid" to Tommy Gate Company's location.
 - c. Must be clearly marked with the **RETURN GOODS AUTHORIZATION NUMBER** on the outside of the package.

Warranty claims must be submitted by the Authorized Distributor on behalf of their customer as part of their customer assistance.

Warranty claim acceptance or rejection is based solely upon defective part inspection and a review of the claim date (outlined in step 5 above) as they apply to the requirements of the Tommy Gate Warranty. Claim reimbursement after acceptance is governed by those allowances previously agreed upon between Tommy Gate Company and the Authorized Distributor (as outlined in steps 1-4 above).

Any warranty claims submitted without a **WARRANTY REQUEST NUMBER** or **RETURN GOODS AUTHORIZATION NUMBER** and the necessary information will be denied.

SERIES 650

REPAIR PARTS DRAWING

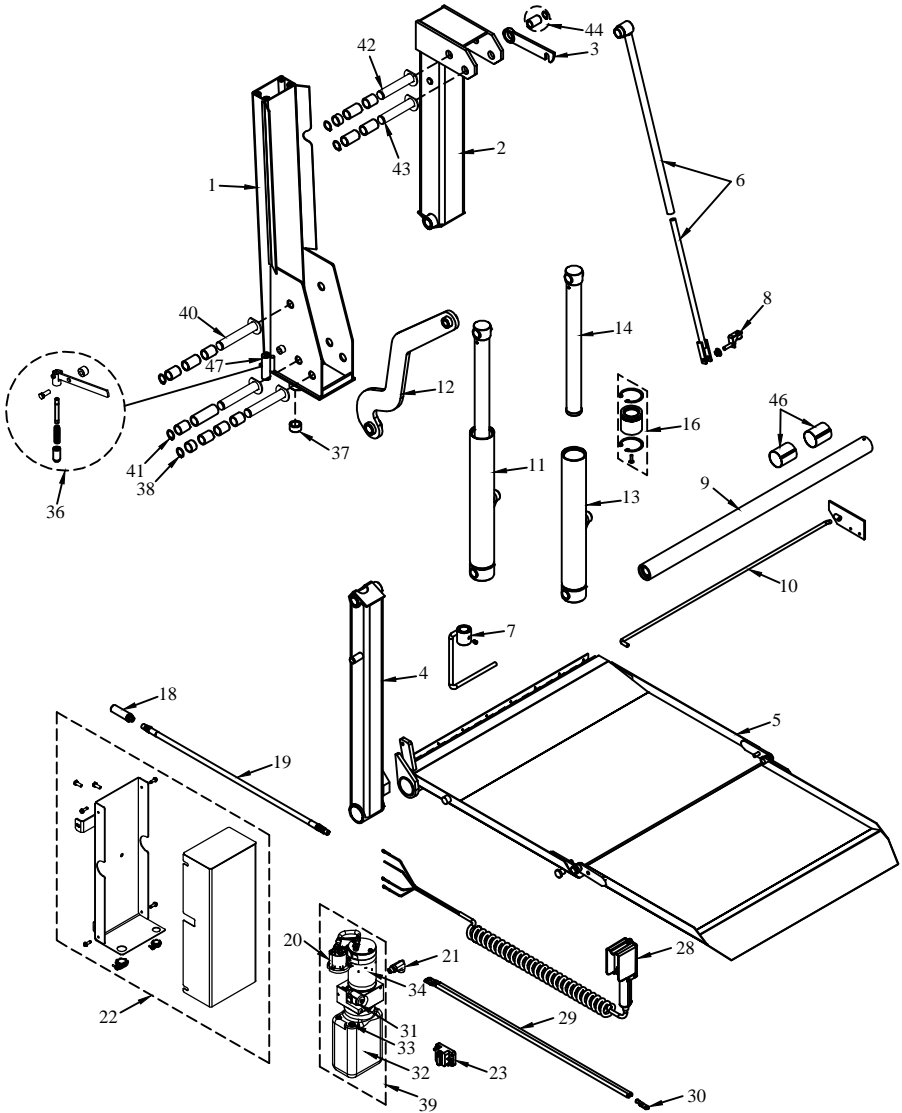



SERIES 650

REPAIR PARTS LIST

ITEM#	DESCRIPTION
1	Support Tube Assembly
2	Main Lift Tube
3	Platform Latch
4	Vertical Lift Tube
5	Platform
6	Self-close Tube Kit
7	Flipper Arm Self-closing Rod
8	Flipper Stop
9	Hinge Tube
10	Torsion Spring
11	Cylinder with Hose
12	Lift Arm
13	Cylinder Barrel Kit
14	Cylinder Shaft Kit
16	Guide Bushing and Seal Kit
18	Flow Control
19	Hydraulic Hose
20	Raise Solenoid
21	90° Pump Elbow
22	Pump Box Only
23	Manual Reset Circuit Breaker
28	Timed Pendant Control
29	4 Ga. 2 Wire Electrical Cable
30	Copper Lug
31	Release Solenoid
32	Tank
33	Vent Plug
34	Motor Only
36	Pivot Latch Kit
37	Lower Pivot Bushing
38	Pin Kit (Lower Cylinder)
39	Pump and Motor
40	Pin Kit (Lower 4x4 Lift Tube)
41	Pin Kit (Lower S-Arm)
42	Pin Kit (Upper Cylinder)
43	Pin Kit (Upper 3x3 Lift Tube)
44	Latch and Self-close Bushing Kit
46	Platform Wear Bushing Kit
47	Pivot Arm Pin Sleeve

Note:

The item number **is not** the part number. Please have the model number and serial number available before calling for repair parts.



**America's First Name
in Liftgates™**

Manufacturing Plant:
83 Bus Brown Drive
Woodbine, Iowa 51579
FAX (712) 647-2417

Corporate Offices:
33717 N. Scottsdale Rd. Ste 120
Scottsdale, AZ 85266
FAX (602) 955-3902

(712) 847-8000
www.tommygate.com

