

1340, 1540 AND 1640 SERIES G2 PARTS DRAWING

FOR MODELS 54, 60, 64

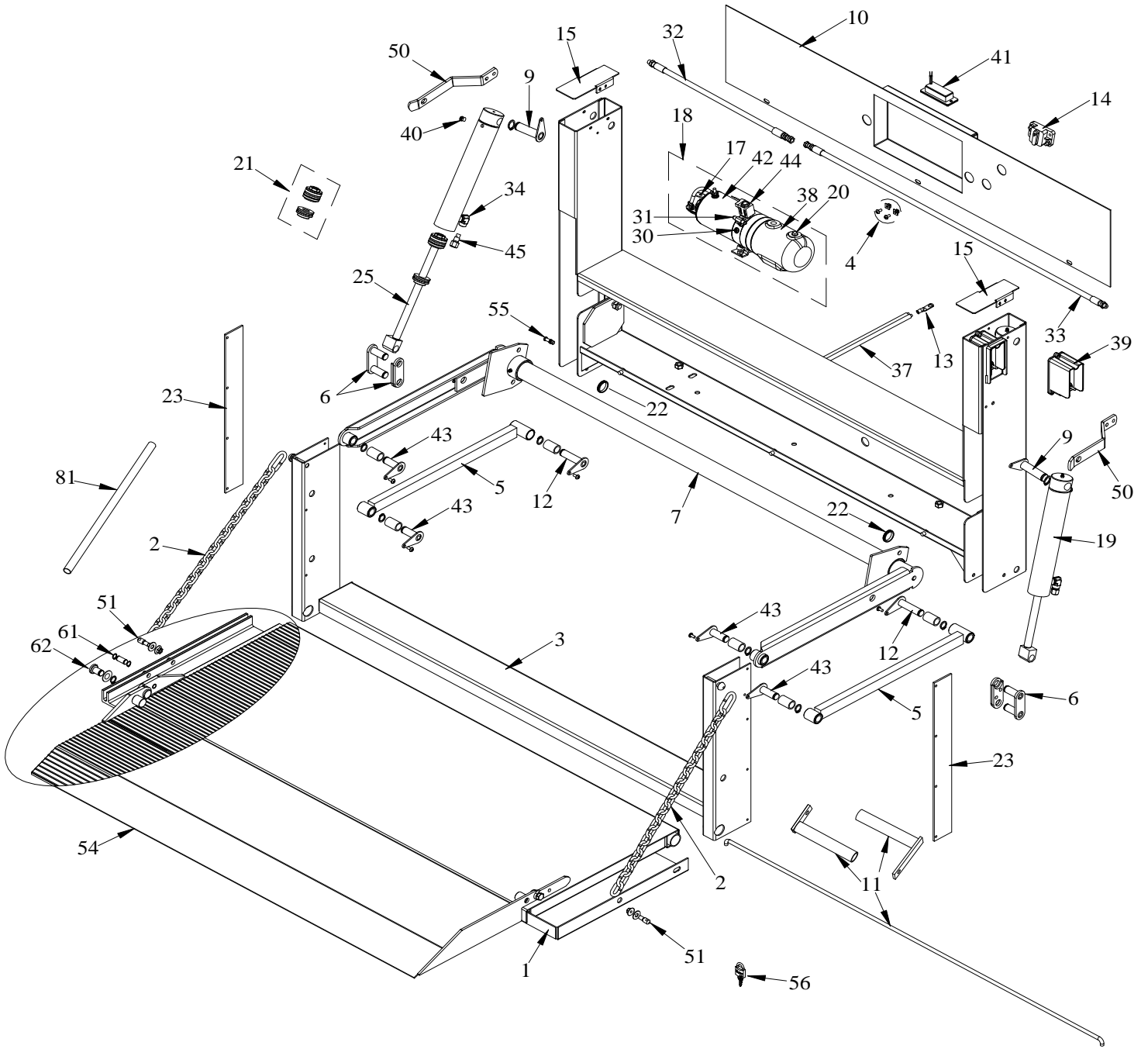

1340, 1540 & 1640 G2 SERIES PARTS LIST

Draw. Ref.	Part No.	Description	Qty Required
1	004833	54 G2 27" Treadplate Replacement Platform	1
	004834	54 G2 38" Treadplate Replacement Platform	1
	004835	54 G2 42" Treadplate Replacement Platform	1
	001631	54 38" EA Replacement Platform	1
	004820	54 48 EA Replacement Platform	1
	004866	60 G2 27" Treadplate Replacement Platform	1
	004867	60 G2 38" Treadplate Replacement Platform	1
	004868	60 G2 42" Treadplate Replacement Platform	1
	001632	60 38" EA Replacement Platform	1
	004799	60 48 EA Replacement Platform	1
	001633	64/65 38" EA Replacement Platform	1
004798	64/65 48" EA Replacement Platform	1	
2	003883	Replacement G2 Treadplate Platform Chain	2
	006473	Replacement 38" EA Platform Chain	2
	013650	Replacement 48" EA Platform Chain	2
3	002044	54-40 G2 Replacement Sub Assembly	1
	002045	60-40 G2 Replacement Sub Assembly	1
	002046	64-40 G2 Replacement Sub Assembly	1
4	001111	License Plate Mount Kit	1
5	007007	G2 Replacement Lower Arm w/Pins & Bushings	2
6	002182	G2 Replacement Clevis Cylinder Assembly	2
7	002040	54-40 G2 Replacement Upper Arm Assembly	1
	002041	60-40 G2 Replacement Upper Arm Assembly	1
	002042	64-40 G2 Replacement Upper Arm Assembly	1
9	002180	7/8" Replacement G2 Upright Back Cylinder Pin	2
10	004837	Replacement Box Cover (54 G2)	1
	004949	Replacement Box Cover (60 G2)	1
	004950	Replacement Box Cover (64 G2)	1
11	001220	27" TP Hinge Tube Spring Holders (no spring)	1
	008025	Torsion Spring Kit (54)	1
	008083	Torsion Spring Kit (54) Deep Platform	1
	008026	Torsion Spring Kit (60)	1
	008084	Torsion Spring Kit (60) Deep Platform	1
	008027	Torsion Spring Kit (64/65)	1
008085	Torsion Spring Kit (64/65) Deep Platform	1	
12	002181	3/4" Replacement G2 Upright Back Arm Pin & Bushing	2
13	000992	Replacement Copper Lug	6
14	000998	Replacement 150 Amp Manual Reset Circuit Breaker	1
15	002015	Replacement G2 Upright Cap	2
17	000967	Replacement Raise Solenoid-3 Post	1
18	000968	Replacement 1340 G2 Pump & Motor Unit (2050psi)	1
	000969	Replacement 1540 G2 Pump & Motor Unit (2350psi)	1
	000970	Replacement 1640 G2 Pump & Motor Unit (2500psi)	1
19	000971	Replacement G2 Cylinder	2
20	000989	Replacement Vent Plug	1
21	001138	G2 Cylinder Repair Kit (after serial # 470166M)	2
22	000972	Replacement Split Plastic Grommet Kit	2
23	002143	Replacement G2 Sub Assembly Belting	2
25	001211	Replacement G2 Cylinder Shaft Complete (40) (after serial # 470166M)	2
30	000973	Replacement Monarch Lee Check Valve (after serial # M-335705 1000# & 1300#) (after serial # M16-26635 1600#)	1
31	000974	Replacement G2 T-Fitting (Pump & Motor)	1
32	000975	Replacement 1/4"X21" Hydraulic Hose-Left (G2)	1
33	000976	Replacement 1/4"x52" Hydraulic Hose-Right (54 & 60 G2)	1
	000977	Replacement 1/4"x56.63" Hydraulic Hose-Right (64 G2)	1

1340, 1540 & 1640 G2 SERIES PARTS LIST

Draw. Ref.	Part No.	Description	Qty Required
34	000978	Replacement 1/4"x1/4"x90 Degree Steel Cylinder Elbow	2
37	004570	Replacement 4 Ga. 2 Wire Electric Cable w/Lugs-26 ft.	1
38	000957	Replacement 1.5qt. Monarch Plastic Tank (G2) **	1
39	000987	Replacement Fixed Control	1
40	000979	Replacement Vent Plug - Cylinder (Rail & G2)	2
41	004036	Replacement License Plate Light & Bracket (154C)	1
	010199	Replacement License Plate Light & Bracket (H1)	1
42	000958	Replacement 12 Volt Motor-Only (Monarch)**	1
43	002183	3/4" Replacement G2 Upright Front Arm Pin	4
44	009645	Release Solenoid External Assembly w/Connector	1
45	000959	Replacement Flow Control (G2)	2
47	N/A	Replacement Pump (only) w/1.5qt. Tank 1340 G2 (2050psi) (Discontinued - See Drawing Ref 18)	1
	N/A	Replacement Pump (only) w/1.5qt. Tank 1540 G2 (2350psi) (Discontinued - See Drawing Ref 18)	1
	N/A	Replacement Pump (only) w/1.5qt. Tank 1640 G2 (2500psi) (Discontinued - See Drawing Ref 18)	1
50	002017	G2 Replacement Latch Kit	2
51	002020	Replacement Platform Latch Pin Assembly (G2)	2
54	000960	G2 54-F11+4 Replacement Treadplate Flipper	1
	000961	G2 54-F11+7 Replacement Treadplate Flipper	1
	001881	54-F11 Replacement EA Flipper	1
	000962	G2 60-F11+4 Replacement Treadplate Flipper	1
	000963	G2 60-F11+7 Replacement Treadplate Flipper	1
	001882	60-F11 Replacement EA Flipper	1
	001883	64/65-F11 Replacement EA Flipper	1
55	001010	G2 Replacement Drop Away Pin Assembly	1
56	000966	Replacement Padlock w/Keys	1
61	004712	EA Replacement Platform Chain Pin (1.079")	2
62	004717	EA Replacement Flipper Rivet	2
81	006514	Replacement Cloth Chain Cover 20"	2
	006516	Replacement Cloth Chain Cover 29"	2

**Please provide the liftgate Model and Serial numbers when ordering repair parts.
 Note: The above prices are for standard equipment only. Call the factory for pricing of optional equipment or special