

# INSTRUCTION SHEET SUPPLEMENT

1. Mark two holes on vehicle as shown in drawing or use template.
2. Center punch at marks to keep drill from walking.
3. Drill two 9/32" diameter holes through sheet metal.

## Tools Required:

3/8" Drill  
3/16" Drill Bit  
9/32" Drill Bit  
Hammer  
Center Punch  
Ratchet &  
3/8" Socket  
Pencil or  
Fine Marker  
Tape Measure

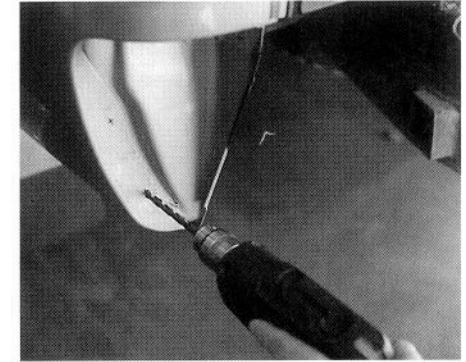
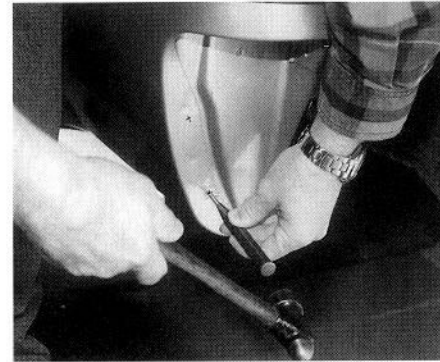
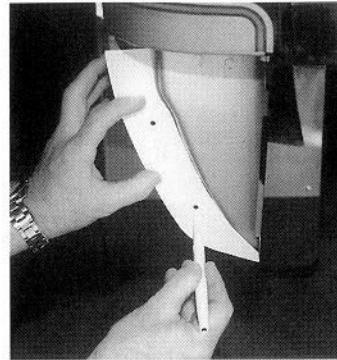
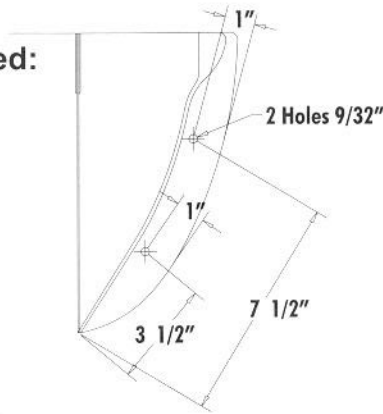

4. Position box insert in box corner and drill through plastic with a 3/16" diameter bit or mark hole centers from the back side and drill in the open.

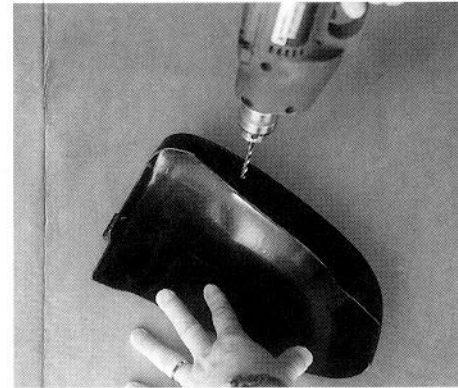
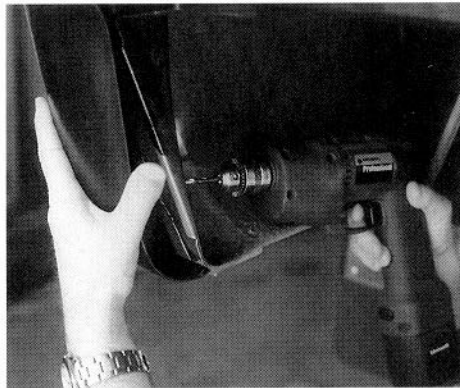

5. Install provided screws from back side to secure box insert to vehicle.



Installation Complete



## LIVERNE BOX INSERT 1999 FORD

PARTS INCLUDED

- 1 - # 104350 Right Hand
- 1 - # 104351 Left Hand
- 4 - #100003 / 1/4-20 x3/4  
Self Tapping Screws

**LIVERNE**  
TRUCK  
EQUIPMENT  
INC.  
1200 E. Birch Street  
Brandon, SD 57005

**800-533-5328**

# INSTRUCTION SHEET SUPPLEMENT

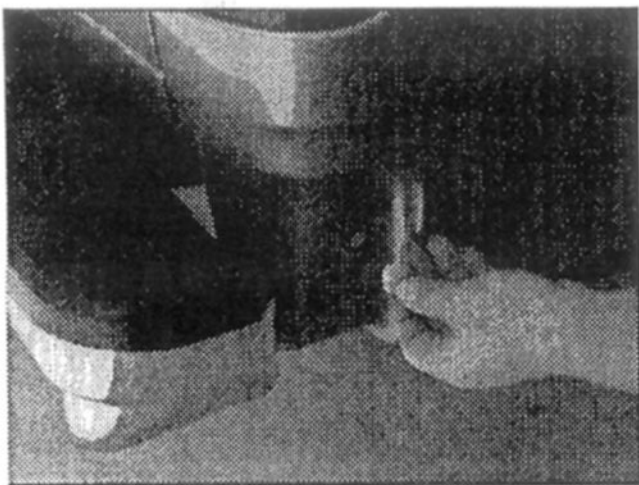

Remove body plug.

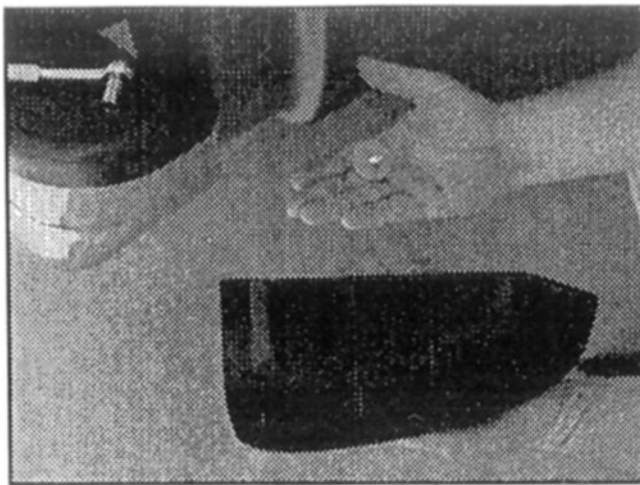

Identify Box Insert, screw  
and washer.

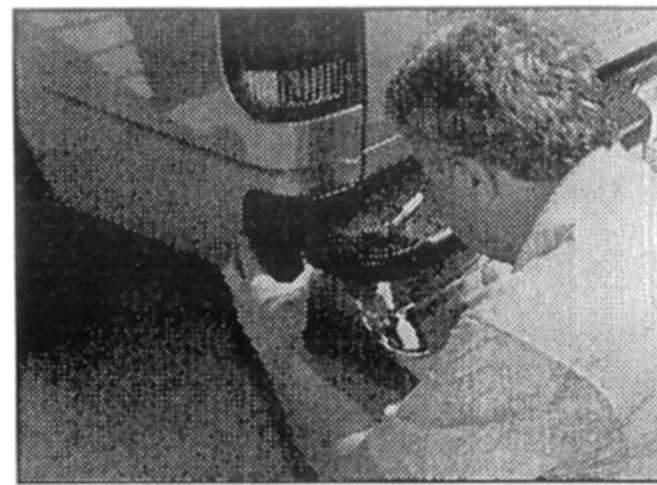

Position Box Insert and  
carefully start screw.

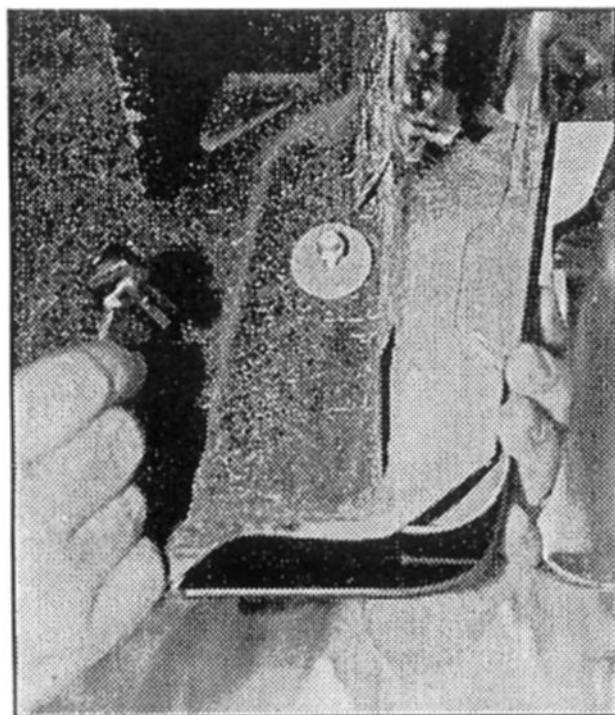

Tighten using 3/8" socket.

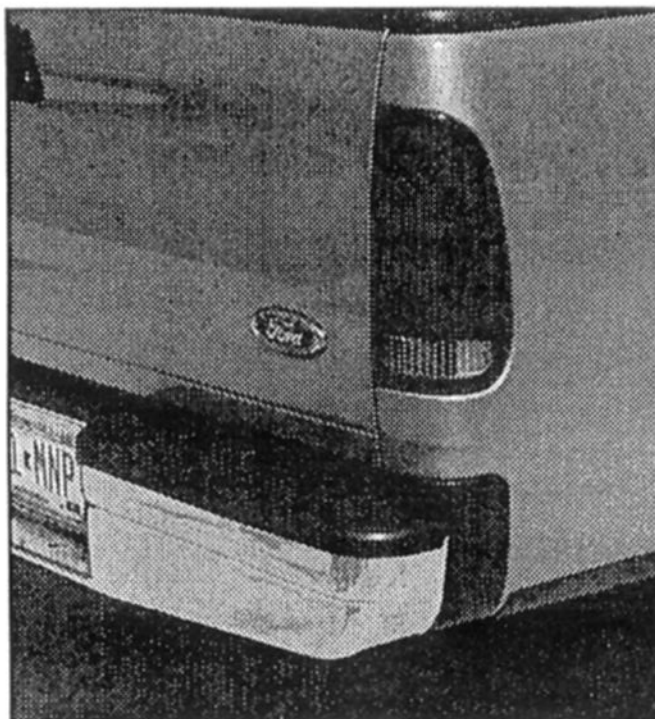

INSTALLATION COMPLETE

**LIVERNE**  
**BOX INSERT**  
**1997 FORD**

**LIVERNE**  
TRUCK  
EQUIPMENT  
INC.

**800-533-5328**