

ITEM NO.	QTY.	PART NO.	DESCRIPTION
1	1	011430 *	(95) 60+12 ALUMINUM SC/TA PLATFORM COMPLETE
2	1	005237 *	5/8' X 96-3/4 RAIL TORSION SPRING (95)
3	1	001989	5/8' RAIL TORSION SPRING HOLDER (PASS.)
4	1	011157	5/8' RAIL TORSION SPRING HOLDER (DR)
5	5	000582	1-1/2' NARROW RIM MACHINE BUSHING
6	1	004720	1/4"x2' COTTER PIN
7	2	000521	1/2-13x1-1/4' HHCS GR5
8	2	000573	1/2' SPRING LOCK WASHER
9	1	000596	3/8-16x1-1/2'USS SOC HD CAP
10	2	000553	3/8-16 LARGE FLANGE LOCK NUT
11	1	010406	SELF CLOSE ARM (RIGHT) WITH HANDLE
12	1	001902	1/2"DIA.x1-1/2' CHROME PLATED SHOULDER BOLT
13	1	001914	0.115"WIREX0.75"x5.5' EX. SPRING
14	2	009540	CAUTION DECAL - TORSION SPRING
15	1	002657	HANDLE GRIP
16	1	013291	5/16' TORSION SPRING SPACER
17	1	011155	TORSION ARM RAIL (DR)
18	2	004721	1/8"x3/4' COTTER PIN
19	1	095087	REPAIR (25/30) RAIL TORSION ASSIST SPRING INSTRUCTIONS

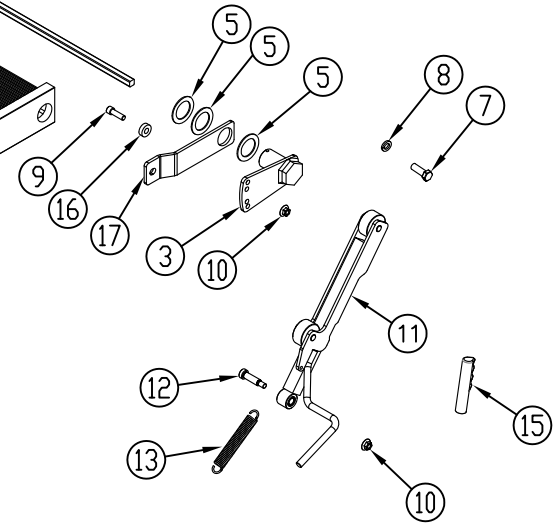

NOTE: "\*" INDICATES INDIVIDUAL PARTS ARE LISTED IN ACCOUNTING.

				THIRD ANGLE PROJECTION		FILENAME:		WOODBINE MFG. CO.															
						SYMBOLY PER ANSI Y14.5		BUS BROWN DRIVE															
				<table border="1"> <tr> <th>DECIMAL</th> <th>2PLC</th> <th>3PLC</th> </tr> <tr> <td>MACHINE SAW, DRILL</td> <td>.030</td> <td>.015</td> </tr> <tr> <td>SHEAR, PUNCH FORM</td> <td>.060</td> <td>.030</td> </tr> <tr> <td>TORCH, WELDING ROUGH CAST</td> <td>.090</td> <td>.060</td> </tr> </table>		DECIMAL	2PLC	3PLC	MACHINE SAW, DRILL	.030	.015	SHEAR, PUNCH FORM	.060	.030	TORCH, WELDING ROUGH CAST	.090	.060	DRAWN BY. JAR		NOTES:		WOODBINE, IOWA 51579	
DECIMAL	2PLC	3PLC																					
MACHINE SAW, DRILL	.030	.015																					
SHEAR, PUNCH FORM	.060	.030																					
TORCH, WELDING ROUGH CAST	.090	.060																					
				DRAWN/DATE 1/5/12		712-647-2050																	
B	3/26/13	ADDED (2) 582, (1) 521, (1) 573, (1) 13291, (1) 11155, AND (2) 4721; REPLACED 594, 11158, 1991, 5239 W/ 596, 11157, 1989, 5237	JCB	852	APPVD/DATE		TITLE		THE INFORMATION HERE IS CONFIDENTIAL AND MUST NOT BE USED IN ANYWAY DETRIMENTAL TO THE INTEREST OF WOODBINE MFG.														
A	1/10/12	RELEASE TO PRODUCTION	JAR	570	SALES CATEGORY		(95) 60+12 SC/TA REPLACEMENT ALUMINUM PLATFORM																
REV.	DATE	CHANGE RECORD	BY	APPVD	ECN	DRAFT 2'	ANGULAR ±1'	PRODUCT LINE	SCALE 1:15	FIN. WT.	PART NO. 11737												