

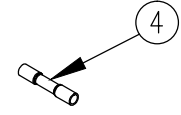

ITEM NO.	QTY.	PART NO.	DESCRIPTION
1	1	004457	MONARCH UNIT 319-0295 (2050) 1340 G2
2	0.335 GAL.	009034	HYDRAULIC OIL
3	1	004403*	VENT PLUG
4	1	009089	16-14 HEAT SHRINK BUTT CONNECTOR
5	1	9077	3/16"x7-1/2" CABLE TIE
6	1	14839	VENT PLUG WARNING TAG
7	1	95048	REPLACEMENT POWER UNIT INSTALLATION INSTR.

*ACCOUNTING-DO NOT USE FOR B.O.M.

6 ○ WARNING

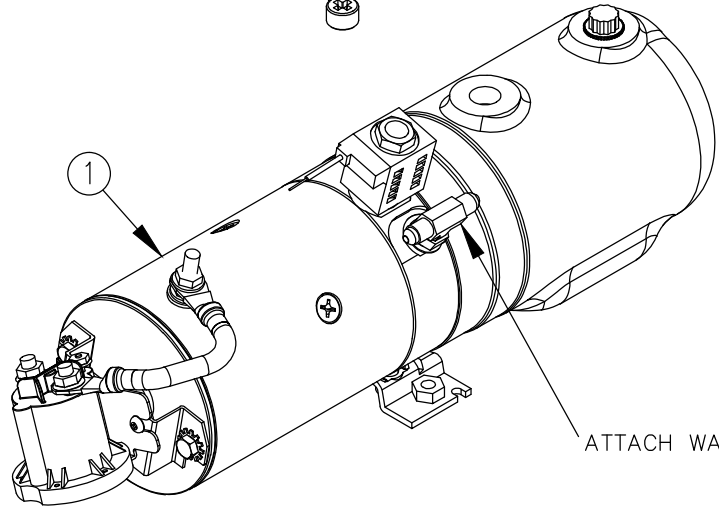
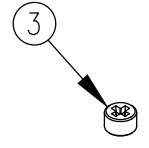
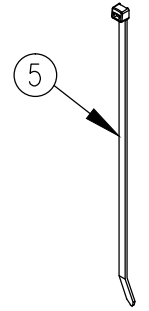

ATTACH WARNING TAG TO TEE WITH CABLE TIE

REV.	DATE	CHANGE RECORD	BY	APPVD	ECN	THIRD ANGLE PROJECTION			FILENAME:		NOTES:	WOODBINE MFG. CO. BUS BROWN DRIVE WOODBINE, IOWA 51579	
						DECIMAL	2PLC	3PLC	SYMBOLY PER ANSI Y14.5	DRAWN BY.			
B	8/17/16	ADDED (1) 9077 AND (1) 14839	JCB		1679	MACHINE SAW, DRILL	.030	.015	DRAWN/DATE	JCB		 THE INFORMATION HERE IS CONFIDENTIAL AND MUST NOT BE USED IN ANYWAY DETRIMENTAL TO THE INTEREST OF WOODBINE MFG.	
A	6/3/11	RELEASED TO PRODUCTION	JCB		449	SHEAR, PUNCH FORM	.060	.030	APPVD/DATE				REPLACEMENT 1642 G2 POWER UNIT (2750PSI)
						TORCH, WELDING ROUGH CAST	.090	.060	SALES CATEGORY	PRODUCT LINE	SCALE	FIN. WT.	PART NO.
						DRAFT 2'		ANGULAR ±1'			1:4	23.6	11312