

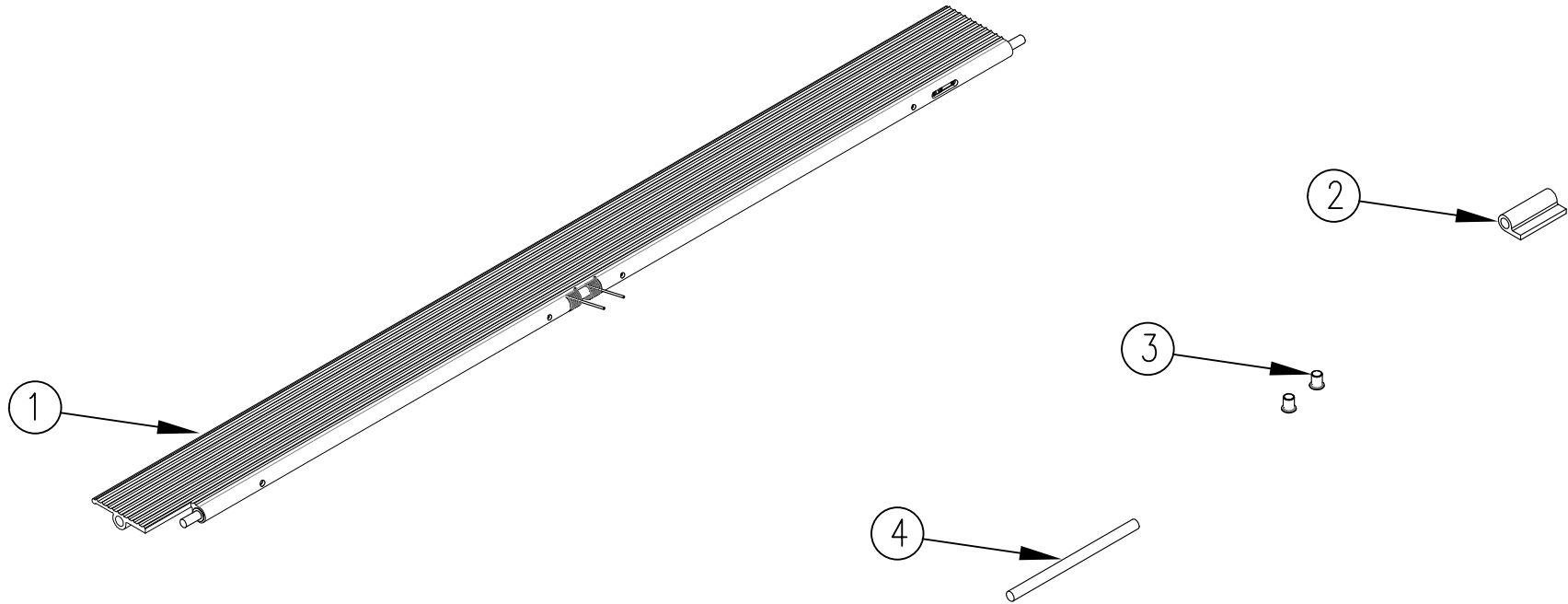

ITEM NO.	QTY.	PART NO.	DESCRIPTION
1	1	014462	CART STOP FLIPPER ASSEMBLY (73) RIGHT
2	1	013418	CART STOP HALF BUSHING
3	2	014465	3/8" x 5/16" x 1/2" PLASTIC FLANGE BUSHING
4	1	013532	.38"DIA.x6"STAINLESS STEEL ROD
5	1	095179	REMOVABLE CART STOP (IN TAPER) REPL. INSTR.



REV.	DATE	CHANGE RECORD	BY	APPVD	ECN	THIRD ANGLE PROJECTION	FILENAME:	SYMBOLY PER ANSI Y14.5	NOTES:	WOODBINE MFG. CO. BUS BROWN DRIVE WOODBINE, IOWA 51579 712-647-2050		
C	1/13/16	ADDED 13532	GDB		1562	MACHINE SAW, DRILL		DRAWN BY: JCB		<small>THE INFORMATION HERE IS CONFIDENTIAL AND MUST NOT BE USED IN ANYWAY DETRIMENTAL TO THE INTEREST OF WOODBINE MFG.</small> 		
B	8/7/15	REMOVED 12782, 11223, 10646, 10373, AND 95124; ADDED 14462, 14465, AND 95179	GDB		1331	SHEAR, PUNCH FORM		DRAWN/DATE: 12/9/13				
A	12/9/13	RELEASED TO PRODUCTION	JCB		1019	TORCH, WELDING ROUGH CAST		APPVD/DATE	TITLE: REPLACEMENT RIGHT CART STOP (IN TAPER) 73			
						DRAFT 2'	ANGULAR ±1'	SALES CATEGORY	PRODUCT LINE		SCALE 1:6	FIN. WT.