

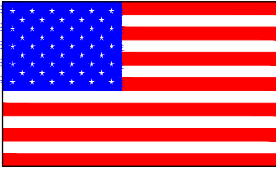

Woodbine, Iowa



Made in America

OWNER'S / OPERATOR'S MANUAL

- Safety Information
- Warranty Information
- Operator's Instructions
- Maintenance Instructions
- Parts List

Railgate Series 1600 & 2000

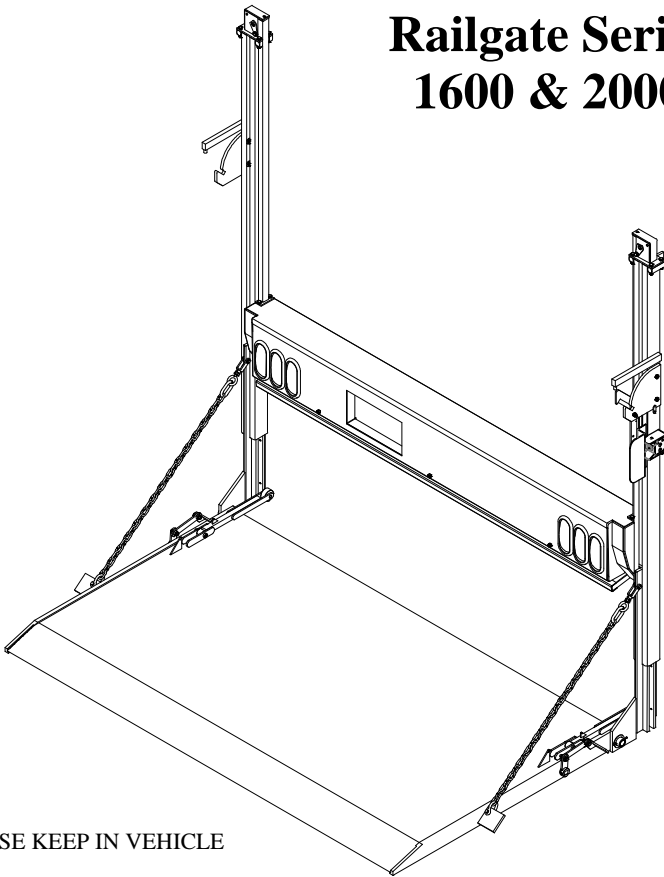

PLEASE KEEP IN VEHICLE

CAUTION

Before installing or using this Lift Gate, please observe the Vehicle Loading Limitations. These loading limitations are outlined in the Vehicle Owner's Manual and the Safety Compliance Certification Label located on the driver's door pillar. **CAUTION**

CAUTION

TABLE OF CONTENTS

<u>Introduction</u>	<u>Page#</u>
To the Owner\Operator	3
<u>Safety Decals</u>	
Location and Descriptions	4 - 6
Decal Replacement	6
<u>Operator's Instructions</u>	
Railgate Terms and Method of Operation	7
Self Close Operator's Instructions	8 & 9
Torsion Spring Operator's Instructions	10 & 11
Retention Ramp Operator's Instructions	12
<u>Electrical Wiring Diagrams</u>	
Standard Fixed Control	13
Optional Pendant Control	14
Power Unit Control Circuit	15
<u>Maintenance and Service</u>	16
<u>Troubleshooting</u>	17
<u>Warranty</u>	
Standard Warranty	18
Warranty Claims Handling Procedure	19
<u>Repair Parts List</u>	
Repair Parts Drawing	20
Bottle Rack Repair Parts Drawing	21
Aluminum Cartstop Repair Parts Drawing	22
Repair Parts Descriptions	23
<u>Service Records</u>	27
<u>Contact Information</u>	28

TO THE OWNER\OPERATOR:

Read this manual completely before using your gate. Operate and maintain your gate safely as outlined in this manual. Be sure you read and understand all operating, safety, maintenance and service information. Should you need repair or service information, contact Tommy Gate or an authorized distributor for assistance.



This is the safety alert symbol. It is used to alert you to potential personal injury hazards. Obey all safety messages that follow this symbol to avoid possible injury or death.



DANGER indicates an imminently hazardous situation which, if not avoided, will result in death or serious injury.



WARNING indicates a potentially hazardous situation which, if not avoided, could result in death or serious injury.



CAUTION indicates a potentially hazardous situation which, if not avoided, may result in minor or moderate injury.



CAUTION indicates a potentially hazardous situation which, if not avoided, may result in property damage.

Safety is a primary concern in the design and manufacture of our products. Unfortunately, our efforts to provide safe equipment can be wiped out by a single careless act of an operator.

Accident prevention and safety are dependent upon the awareness, concern, prudence and proper training of the personnel who operate, transport, maintain and store this equipment. It is your responsibility to use good judgment in the operation of this equipment.

It has been said that "**the best safety device is an informed, careful operator.**" We ask you to be that kind of operator.

DECAL LOCATIONS AND DESCRIPTIONS

Locate and read all decals prior to operating gate
REPLACE IF MISSING OR NOT READABLE

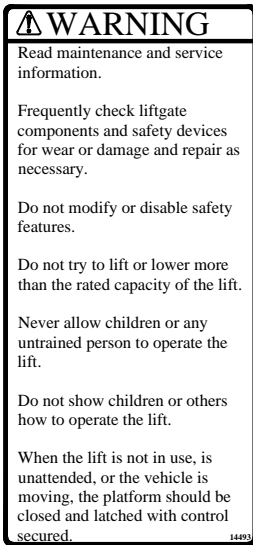

Decal No. 1
 Located on the passenger side upright.

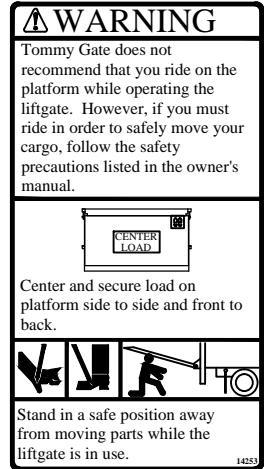

Decal No. 4
 Located on the passenger side platform lid end.

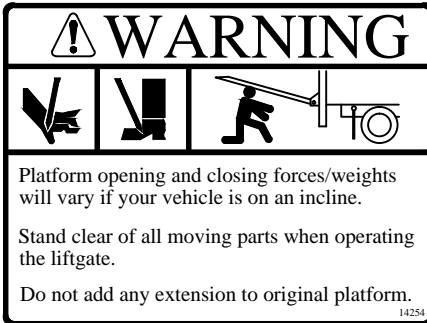

Decal No. 2
 Located on the outside right-hand corner of the platform.

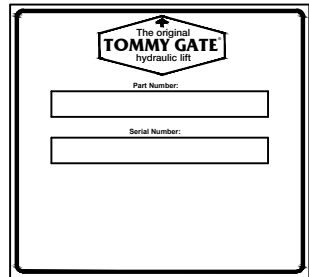

Decal No. 5
 Located on the inside of the main frame.
 Positioned over the top of the pump & motor unit.
 Located on the driver side of upright.



Decal No. 3
 Located on the control shield.

DECAL LOCATIONS AND DESCRIPTIONS

	CAUTION	
<p><u>Failure to lubricate properly could cause platform to stick or drop suddenly.</u></p> <p>Sliders, uprights, roller chains, and pivot points must be kept lubricated to prevent the bearing areas from becoming dry.</p> <p>Use clean, high-quality, nondetergent, petroleum-based oil- <u>not grease.</u></p> <p>Nondetergent oil weight to use: Below freezing- 10W Above freezing- 20W</p>		
		9545

Decal No. 6
 Located on the passenger side latch.

	WARNING	
<p>Read operator's manual before operating equipment.</p> <p>Do not modify lift or its safety features.</p> <p>Use only Tommy Gate service parts installed by an authorized distributor.</p> <p>If additional assistance is needed, call Tommy Gate at 712-847-8000.</p> <p>Do not exceed the rated lift capacity-</p>		
		9524



Decal No. 7
 Located on the control shield.

<p>Rated Lift Capacity XXX lb or XXX kg</p> <p style="font-size: small;">1600 lbs. 9479 2000 lbs. 9480</p>
--

Decal No. 8
 Located on the control shield.

	<p>WARNING: Cancer and Reproductive Harm- www.P65Warnings.ca.gov</p>	
		15731

Decal No. 9
 Located outside of upright, same side as control.

	DANGER	<p>Before removing box cover do the following.</p> <ol style="list-style-type: none"> 1) Lower platform to ground or close and latch. 2) Disconnect positive battery cable(s).
		

Decal No. 10
 Located on box cover of gate.

	WARNING			DO NOT BEND SAFETY BAR
9546				

Decal No. 11
 Located on the safety bar and the back side of the mainframe.

	CAUTION	
	<p>Spring under high tension</p>	
		9540

Decal No. 12
 Located on driver side slider nose and on passenger side torsion spring holder on models with torsion assist spring.

	WARNING	
<p>Lift gate is not to be used as a scale.</p> <p>Lift gate may lift more than its rated capacity.</p> <p>Be aware of how much is being lifted and never exceed the rated capacity of the lift gate.</p> <p>Be aware of how much is being hauled and never exceed the rated capacity of the vehicle.</p>		
		9044

Decal No. 13
 Located on the passenger side latch.

DECAL LOCATIONS AND DESCRIPTIONS

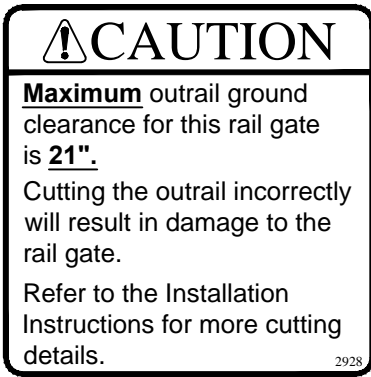

Decal No. 14
Located on the inside of each upright
below the mainframe (ABOVE BED GATES ONLY).



Decal No. 15
Located on the inside of each upright
below the mainframe (BED HEIGHT GATES ONLY).



Decal No. 16
Located on smooth side of flipper
in the center. (RETENTION RAMP
AND RF GATES ONLY).



Decal No. 17
Located on the safety bar in two places (ALL MODELS).
When platform is open and the flipper is folded, located on
rearmost surface of the main platform. One on passenger side and
and one on driver side (RETENTION RAMP and RF GATES ONLY).

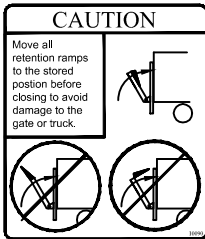

Decal No.18
Located on smooth side of both ramps.
(RETENTION RAMP ONLY)



Decal No. 19
Located outside of upright, same side as control.

DECAL REPLACEMENT

NOTE: When ordering Decals, please have Decal Numbers available.

To replace decal, clear area of grease and dirt with non-flammable solvent and soap and water. Allow to dry. To apply decal, peel off 1/2 of back. Hold decal squarely and apply to cleaned surface. Peel off remaining back and smooth in place. Gently rub decal with a damp rag or sponge to smooth out bubbles.(The decal has a pressure-sensitive adhesive on the back.)

If the liftgate **is** going to be painted, you need to mask the decals before painting. Remove the mask **after** painting so the decals can be read clearly.

RAILGATE TERMS AND METHOD OF OPERATION

Your Tommy Gate is connected to your vehicle battery. The vehicle battery powers a motor, coupled to a hydraulic pump. This motor and pump combination is called a power unit. Flow from the pump extends a cylinder to provide tension to the lift chains that lift the gate platform. A check valve blocks return flow from the cylinder to the pump and a pressure relief valve prevents the gate from being overloaded. The gate platform is lowered by gravity after the "lower" solenoid valve is activated and opened at the pump.

!Warning: Liftgate is not to be used as a scale. Liftgate may lift more than its rated capacity. Be aware of how much is being lifted and never exceed the rated capacity of the liftgate. Be aware of how much is being hauled and never exceed the rated capacity of the vehicle.

Two safety switches are mounted above the safety trip bar. These two switches interrupt power from the "raise" solenoid and direct the power to the "lower" solenoid valve if an obstruction raises the safety trip bar.

A "Low Voltage" condition exists when 7 Volts or less is present at the power unit. A low voltage condition should be corrected as soon as possible. In a "Low Voltage" situation, whether the gate actually raises or lowers depends on how low the voltage is.

Caution: Continuing to operate the the liftgate in the "Low Voltage" condition may result in failure of electrical components in the power unit.

The low voltage condition may be caused by a weak battery, loose or corroded connections, improper ground, or bad electrical cables. This condition may be corrected by just starting the vehicle or replacing the battery.

The terms used to describe parts of the railgate in this manual can be found in (Figure 1).

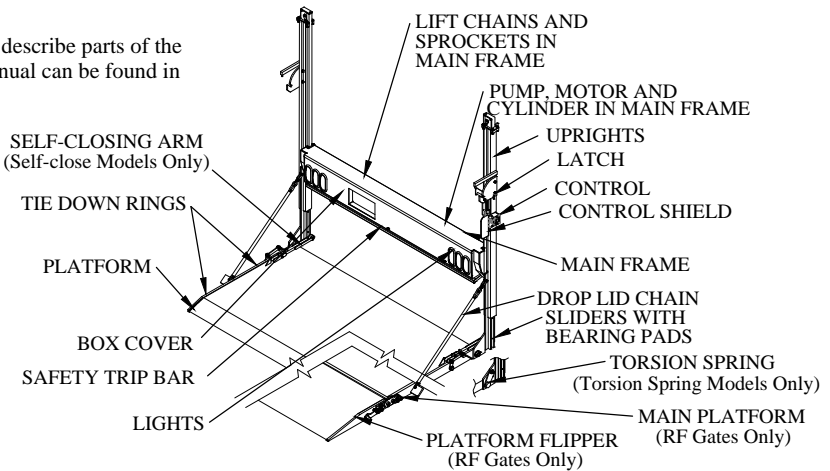

Figure 1: Railgate terms.

!Caution:

**Never leave the truck with the platform on the ground, partially raised, or open.
Never show children or unauthorized personnel how to operate the gate.**

To prevent children or unauthorized personnel from operating the lift, be sure the gate is in the stored position and both the driver's side and passenger's side latches are secured. Make sure the passenger's side latch padlock is installed and the control is deactivated before leaving the truck unattended.

RAILGATE OPERATOR'S INSTRUCTIONS

SELF-CLOSE PLATFORM

- Step 1. **Never show children or unauthorized personnel how to operate the railgate.**
- Step 2. Clear away obstructions that could damage the platform while the load is being raised or lowered.
- Step 3. Be sure to stand to the side of the lift, not behind it when opening the platform.
- Step 4. To turn the control power on, press the "POWER ON" hidden switch once, marked with white rings or circles (located below the Tommy Gate logo). You should see the amber LED "POWER ON" light when the control is armed. To disarm the control press the "POWER ON" hidden switch again. Terms used for the control are shown in (Figure 2).

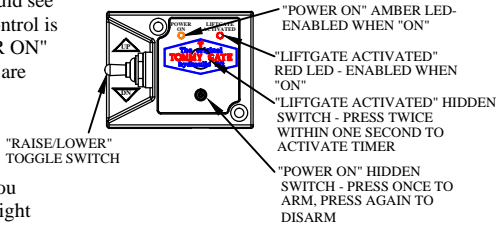

To activate the control, press the "LIFTGATE ACTIVATED" hidden switch twice within one second (located under the Tommy Gate logo). You should see the red "LIFTGATE ACTIVATED" light when the control is activated. To lower the platform, push the control toggle switch down. To raise the platform, push the control toggle switch up. When you remove pressure from the control toggle switch, the operation will stop.

Figure 2: Control terms.

After you have activated the control by pressing the "LIFTGATE ACTIVATED" hidden switch twice within one second(located under the Tommy Gate logo), you have approximately 5 minutes to use the gate. If the gate is not used for approximately 5 minutes, the "LIFTGATE ACTIVATED" timer deactivates the control. If the gate is used during the 5 minutes, the "LIFTGATE ACTIVATED" timer automatically resets for an additional 5 minutes. To reactivate the timer, press the "LIFTGATE ACTIVATED" hidden button twice within one second.

Note: If your gate includes a pendant control, the operation of the pendant will be the same but the "LIFTGATE ACTIVATED" timer will be 90 seconds.

- Step 5. Unlock and remove the latch padlock and pin. Use one hand to move the latch lever back to disengage the latch. With the other hand, raise the platform by moving the control toggle switch to the up position (Figure 2).
- Step 6. When the platform has traveled high enough to prevent the latch from re-engaging(approximately 1 inch), release the latch lever, grasp the platform and move the platform away from the latch plate. With the other hand, lower the platform approximately 4" by moving the control toggle switch to the down position (Figure 3).

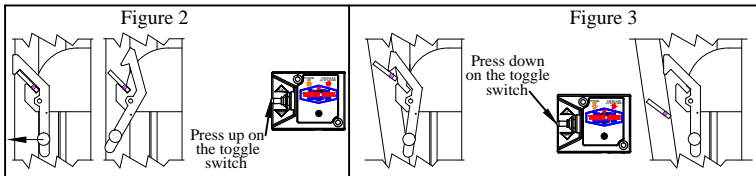

- Step 7. Lower the platform slowly allowing the platform folding mechanism to unfold the platform to the horizontal position. Check to make sure the folding arms have returned to the neutral position (Figure 4).
- Step 8. (Retention Ramp Only) Move the aluminum ramp(s) to the loading position. Refer to Retention Ramp Operator's Instructions on page 12.
- Step 9. To load and use the railgate, center the load on the platform side to side and front to back. Put heavier loads as close to the front of the platform as possible(near truck). Tie down rings are provided to help secure the load (Figure 5).

Note: Railgate capacity depends on both the weight and location of the load. Capacity of the 1600 & 2000 Series is based on a load at capacity located 28" back of the platform front (near truck).

RAILGATE OPERATOR'S INSTRUCTIONS

SELF-CLOSE PLATFORM

- Step 10. (Retention Ramp Only) Move the aluminum ramp(s) to the vertical position.
Refer to Retention Ramp Operator's Instructions on page 12.

⚠ WARNING

Tommy Gate does not recommend that you ride on the platform while operating the liftgate. However, if you must ride in order to safely move your cargo, follow these safety precautions.

- A. Inspect the liftgate prior to use. Do not operate if unsafe conditions exist.
- B. Always secure load in a safe manner to prevent shifting of the load. Center and secure load on platform side to side and front to back.
- C. To avoid overloading the liftgate, derate the capacity by the weight of the operator.
- D. Stand in the area indicated by the footprints in the figure below (Figure 5), keeping hands and feet away from the edges and any moving parts.
- E. Use only a pendant control or a control mounted on the inside of the outrail or truck to operate the lift while standing on the platform.

- Step 11. To raise (or lower) the load, push up (or down) on the toggle switch until the load has reached the desired position. **Be sure the folding mechanism is disengaged.** Do not allow the pump and motor to continue to run after the platform has reached its maximum height or after it has reached an obstruction (Figure 6).

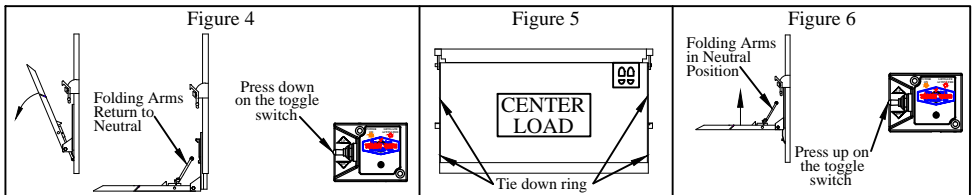

- Step 12. (Retention Ramp Only) Move the aluminum ramp(s) to the travel position.
Refer to Retention Ramp Operator's Instructions on page 12.

Note: To prevent damage to the gate or truck, never close the platform until both of the Retention Ramps are locked in the travel position.

- Step 13. To close the platform, stand to the passenger's side of the platform, not under, behind, or on the platform. With the platform lowered, engage the self-close mechanism with your foot and hold it in the engaged position while slowly raising the platform. After the platform begins to fold, step away from the lift and raise the platform until the latch ear is above the latch plate (Figure 7).

- Step 14. Hold the platform vertical against the latch lever with one hand and slowly lower the platform into the latch plates until the latch lever completely closes over the ear on the platform (Figure 8).

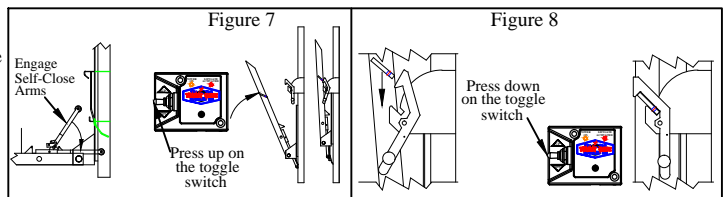

- Step 15. Always install the latch padlock, latch padlock pin, and deactivate the control when not in use.

RAILGATE OPERATOR'S INSTRUCTIONS

TORSION SPRING PLATFORM

- Step 1. **Never show children or unauthorized personnel how to operate the railgate.**
- Step 2. Clear away obstructions that could damage the platform while the load is being raised or lowered.
- Step 3. Be sure to stand to the side of the lift, not behind it when opening the platform.

To turn the control power on, press the "POWER ON" hidden switch once, marked with white rings or circles (located below the Tommy Gate logo). You should see the amber LED "POWER ON" light when the control is armed. To disarm the control press the "POWER ON" hidden switch again. Terms used for the control are shown in (Figure 2).

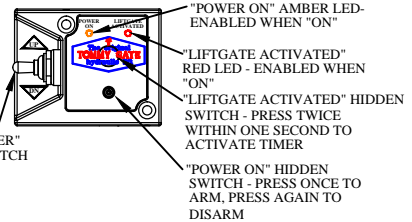

To activate the control, press the "LIFTGATE ACTIVATED" hidden switch twice within one second (located under the Tommy Gate logo). You should see the red "LIFTGATE ACTIVATED" light when the control is activated. To lower the platform, push the control toggle switch down. To raise the platform, push the control toggle switch up. When you remove pressure from the control toggle switch, the operation will stop.

Figure 2: Control terms.

After you have activated the control by pressing the "LIFTGATE ACTIVATED" hidden switch twice within one second (located under the Tommy Gate logo), you have approximately 5 minutes to use the gate. If the gate is not used for approximately 5 minutes, the "LIFTGATE ACTIVATED" timer deactivates the control. If the gate is used during the 5 minutes, the "LIFTGATE ACTIVATED" timer automatically resets for an additional 5 minutes. To reactivate the timer, press the "LIFTGATE ACTIVATED" hidden button twice within one second.

Note: If your gate includes a pendant control, the operation of the pendant will be the same but the "LIFTGATE ACTIVATED" timer will be 90 seconds.

- Step 5. Unlock and remove the latch padlock and pin. Use one hand to move the latch lever back to disengage the latch. With the other hand, raise the platform by moving the control toggle switch to the up position (Figure 10).
- Step 6. When the platform has traveled high enough to prevent the latch from re-engaging (approximately 1 inch), release the latch lever, grasp the platform and move the platform away from the latch plate. With the other hand, lower the platform approximately 4" by moving the control toggle switch to the down position (Figure 11).
- Step 7. Use both hands and unfold the platform to the horizontal position (Figure 12).

Note: Grasp the platform as high as possible to reduce the required opening weight of the platform.

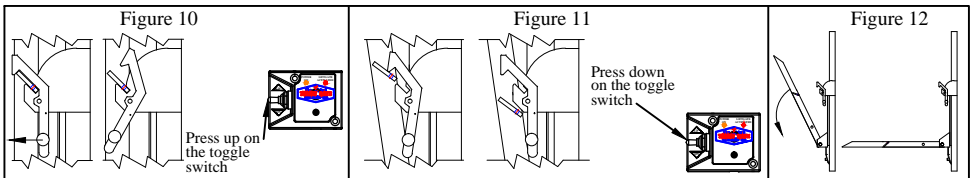

Step 8. (RF gates only) position the platform at a comfortable height to open the folding extension (Figure 13).

Step 9. (RF gates only) Open the folding extension (Figure 13).

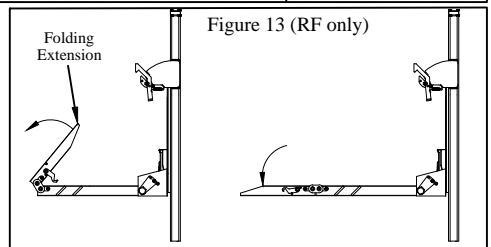

RAILGATE OPERATOR'S INSTRUCTIONS

TORSION SPRING PLATFORM

Step 10. Lower the platform to the ground by pressing down on the toggle switch.

Step 11. To load and use the railgate, center the load on the platform side to side and front to back. Put heavier loads as close to the front of the platform as possible (near truck). Tie down rings are provided to help secure the load (Figure 15).

Note: Railgate capacity depends on both the weight and location of the load. Capacity of the 1600 & 2000 Series is based on a load at capacity located 28" back of the platform front (near truck).

⚠ WARNING

Tommy Gate does not recommend that you ride on the platform while operating the liftgate. However, if you must ride in order to safely move your cargo, follow these safety precautions.

- A. Inspect the liftgate prior to use. Do not operate if unsafe conditions exist.
- B. Always secure load in a safe manner to prevent shifting of the load. Center and secure load on platform side to side and front to back.
- C. To avoid overloading the liftgate, derate the capacity by the weight of the operator.
- D. Stand in the area indicated by the footprints in the figure below (Figure 15), keeping hands and feet away from the edges and any moving parts.
- E. Use only a pendant control or a control mounted on the inside of the outrail or truck to operate the lift while standing on the platform.

Step 12. To raise (or lower) the load, push up (or down) on the toggle switch until the load has reached the desired position. Do not allow the pump and motor to continue to run after the platform has reached its maximum height or after it has reached an obstruction (Figure 16).

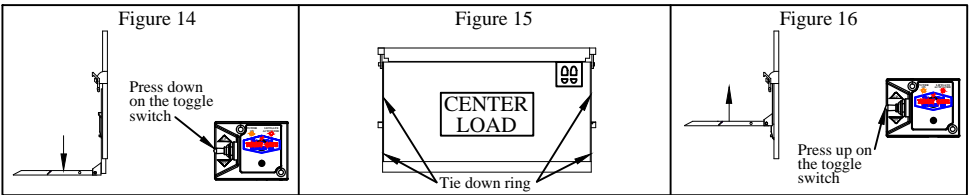

Step 13. (RF gates only) Position the platform at a comfortable height to close the folding extension (Figure 17).

Step 14. (RF gates only) Close the folding extension (Figure 17).

Step 15. To close the platform, stand to the passenger's side of the platform, not under, behind, or on the platform. Position the platform approximately 4" below bed height. Use both hands to fold the platform to the vertical position (Figure 18).

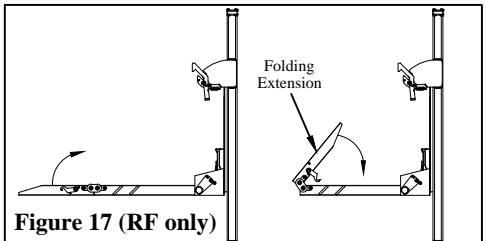

Note: The platform must be lowered 4" below bed height to keep the platform from coming in contact with the mainframe, to prevent the platform ear from going over the latch lever, and reduce the platform closing effort.

Step 16. Hold the platform vertical against the latch lever with one hand and slowly lower the platform into the latch plates until the latch lever completely closes over the ear on the platform (Figure 19).

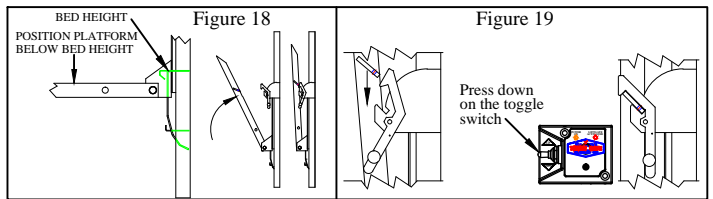

Step 17. Always install the latch padlock, latch padlock pin, and deactivate the control when not in use.

RETENTION RAMP OPERATOR'S INSTRUCTIONS

Retention Ramp locked in various positions.

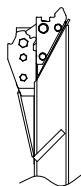

Platform and ramp both in the travel position.

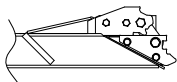

Platform open with ramp in the travel position.

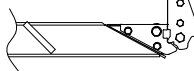

Platform open with ramp in the vertical position.

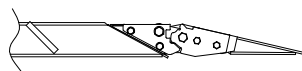

Platform open with ramp in the loading position.

Travel position

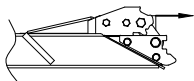

Slide ramp away from gate to unlock from the travel position.

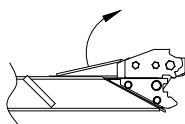

Rotate ramp to position desired.

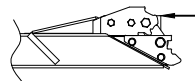

Slide ramp toward gate to lock in the travel position.

Vertical Position

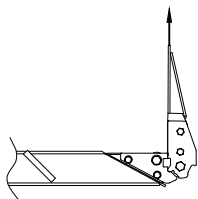

Pull ramp up to unlock from the vertical position

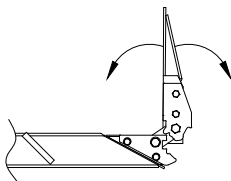

Rotate ramp to desired position

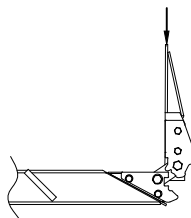

Push ramp down to lock in vertical position

Loading Position

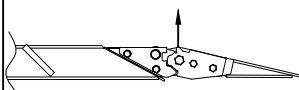

Lift ramp up to unlock from loading position

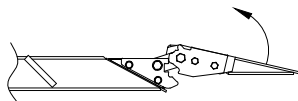

Rotate the ramp to desired position.

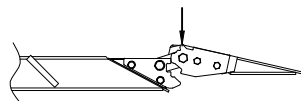

Push ramp down to lock in loading position



ELECTRICAL WIRING DIAGRAM

Low Profile Control - Railgate

!!! PLEASE READ AND FOLLOW ALL DIRECTIONS BEFORE PROCEEDING !!!



NOTE !!! IF GATES ARE NOT WIRED IN ACCORDANCE WITH THIS DIAGRAM YOUR WARRANTY WILL BE VOID.



WELDING NOTE !!! DISCONNECT ALL BATTERY CABLES. ALWAYS DISCONNECT THE GROUND CABLE FIRST. ATTACH THE WELDING GROUND TO THE TRUCK RATHER THAN THE LIFTGATE.

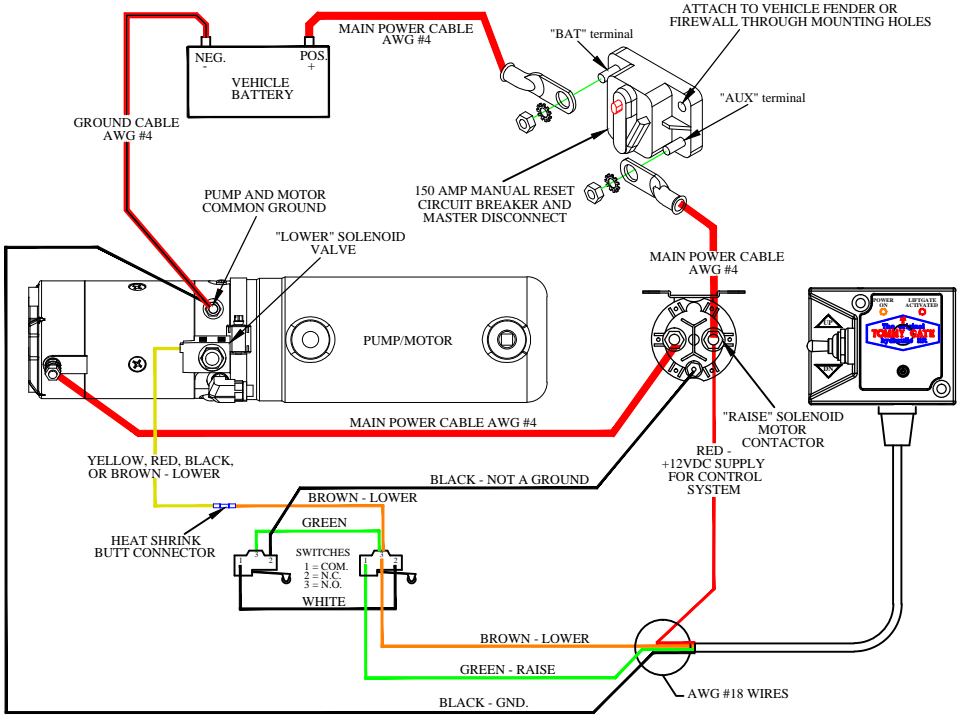

CONTROL OPERATION

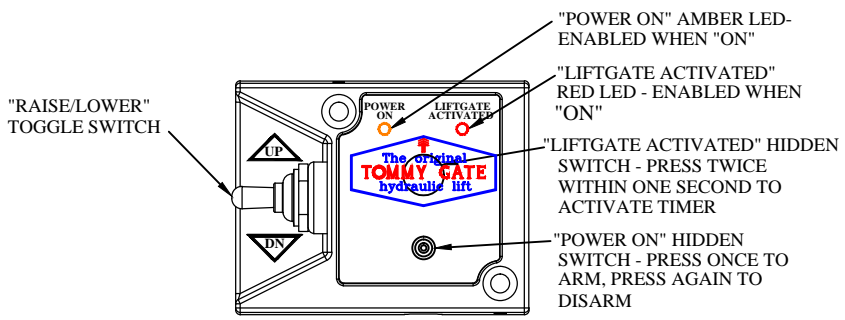



ELECTRICAL WIRING DIAGRAM

Optional Pendant Control - Railgate

!!! PLEASE READ AND FOLLOW ALL DIRECTIONS BEFORE PROCEEDING !!!



NOTE !!! IF GATES ARE NOT WIRED IN ACCORDANCE WITH THIS DIAGRAM YOUR WARRANTY WILL BE VOID.



WELDING NOTE !!! DISCONNECT ALL BATTERY CABLES. ALWAYS DISCONNECT THE GROUND CABLE FIRST. ATTACH THE WELDING GROUND TO THE TRUCK RATHER THAN THE LIFTGATE.

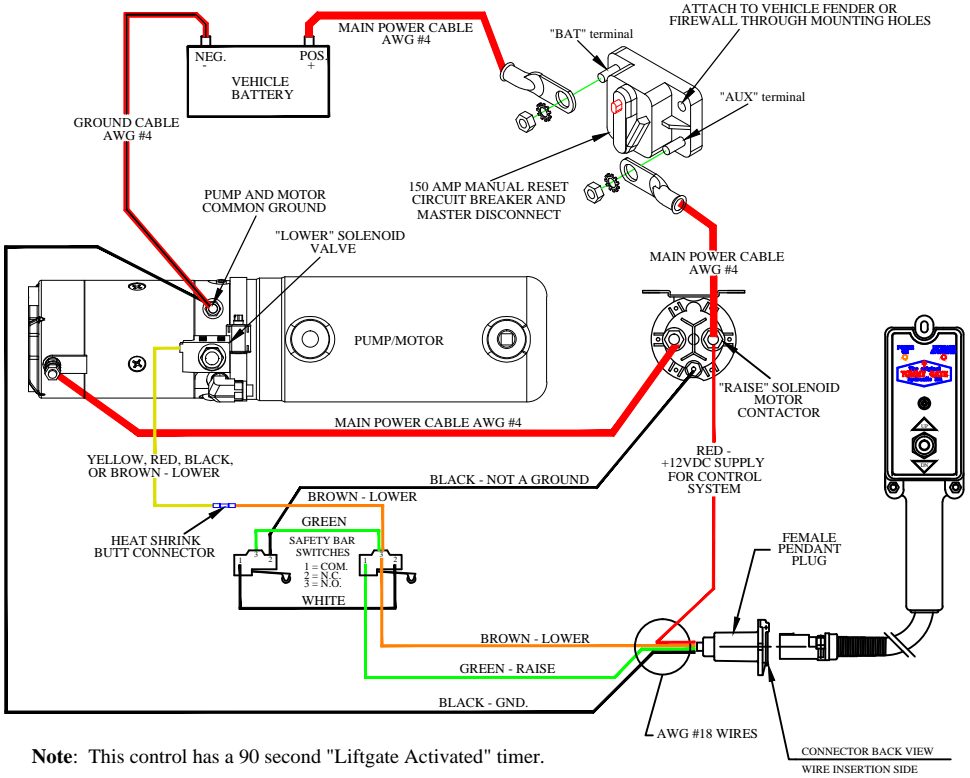

Note: This control has a 90 second "Liftgate Activated" timer.

CONTROL OPERATION

BLINKING AMBER LED INDICATES LOW VOLTAGE CONDITION

"POWER ON" AMBER LED-ENABLED WHEN "ON"

"LIFTGATE ACTIVATED" RED LED - ENABLED WHEN "ON"

"LIFTGATE ACTIVATED" HIDDEN SWITCH - PRESS TWICE WITHIN ONE SECOND TO ACTIVATE TIMER

"POWER ON" HIDDEN SWITCH - PRESS ONCE TO ARM, PRESS AGAIN TO DISARM

"RAISE/LOWER" TOGGLE SWITCH

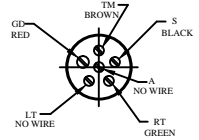
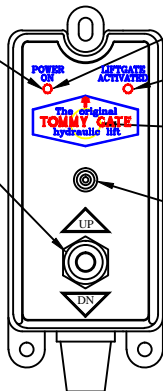

POSITION	WIRE COLOR
S	BLACK
RT	GREEN
LT	NO WIRE
TM	BROWN
A	NO WIRE
GD	RED

POWER UNIT CONTROL CIRCUIT

Legend	
	Solenoid contact
Ⓜ	Motor
⚡	Solenoid coil
⚡	Circuit breaker with manual disconnect and reset
⚡	Safety Trip Bar Limit Switch
—	Battery Wire
—	Primary Wire
---	Grounded through motor chassis
□	Elements within are part of the control
+	Positive 12V
-	Negative battery terminal

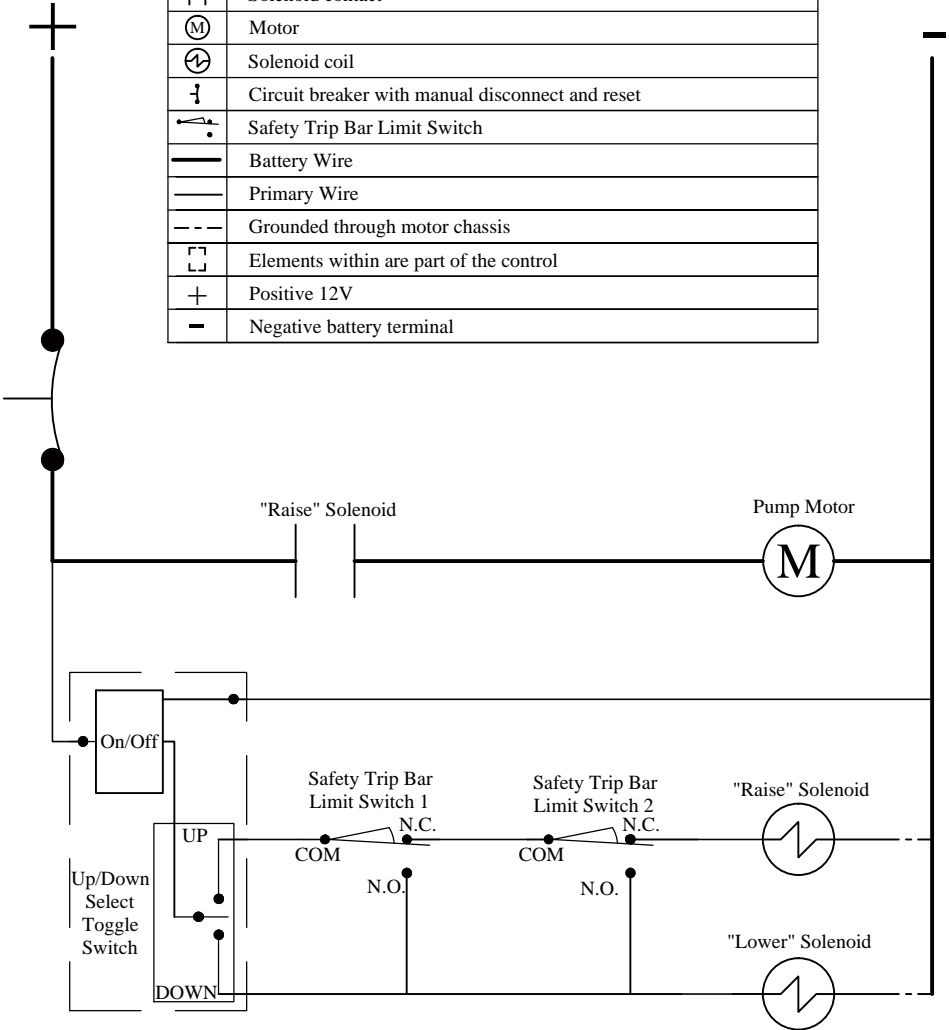

MAINTENANCE AND SERVICE INFORMATION

The Tommy Gate Railgate needs to be serviced every 120 days or 1500 cycles, whichever comes first.

The lift will not be automatically serviced when the vehicle is serviced.

If there is any noticeable problem with the liftgate between service intervals, the liftgate must be taken out of service and checked immediately.

As with any mechanical product, a preventive maintenance program needs to be followed in order to keep the lift in its best operating condition. Please review this information and if you should have any questions please call (712)847-8000. Please have your model number and serial number available.

All installations, re-installations, and repairs of Tommy Gate Railgates should be performed by a qualified authorized distributor that is familiar with its operation and safety features. All replacement parts must be of original quality, and all safety and operational decals must be attached. No modifications are allowed to a Tommy Gate product unless authorized by the Engineering Department at Tommy Gate.

MAINTENANCE PROCEDURE

- (A) Remove the box cover.
- (B) Check for fluid leaks from the cylinder, hoses, and all fittings (replace or repair if found to be leaking).
- (C) Check the oil level in the reservoir. With the liftgate platform at the bottom of its travel, the fluid should be two-thirds full. **BE SURE THE CYLINDER IS COMPLETELY COLLAPSED.** Add Tommy Gate winter grade, ISO grade 32 hydraulic, or Dexron III/ Mercon ATF if needed.
- (D) Check the inside of the box for excessive accumulation of dirt. Clean as necessary.
- (E) Check the roller chains, the platform drop chains, the platform, the uprights, the vertical sliders, the plastic wear pads and the sprockets for damage or excessive wear. Replace any worn or damaged parts.

NOTE: If no issues are found during the 120 day inspections, we recommend that the chains be replaced after 4 years or 10,000 cycles whichever comes first. Chains should be replaced with original Tommy Gate roller chain only.

- (F) Clean the inside surfaces of the uprights with a nonflammable solvent. Lubricate the roller chains, sliders, uprights, and pivot points with clean, high quality, nondetergent, petroleum-based oil- **DO NOT USE GREASE.** Use nondetergent 10W @ (14°F-32°F), 20W @ (32°F-104°F), and 30W @ (104°F-122°F).
- (G) Check the welds on the railgate, its mounting brackets and on the adjacent vehicle structure for cracks or damage. Repair any cracks or damage.
- (H) Check the torque on all mounting bolts and re-tighten as necessary.
- (I) Grease gas bottle rack fence pivot points if equipped.

TROUBLESHOOTING - 1600 & 2000 RAILGATE SERIES

PROBLEM	POSSIBLE CAUSE	REMEDIES
1.) Lift will not operate - "POWER ON" amber LED light does not come on.	<ul style="list-style-type: none"> a.) Control not armed properly. b.) Poor electrical connection. c.) Polarity is reversed. d.) Circuit breaker tripped or disengaged. e.) Faulty control. 	<ul style="list-style-type: none"> a.) Turn the power on at the control by pressing the "POWER ON" hidden switch, marked with white rings or circles (located between the Tommy Gate logo and the toggle switch). b.) Check and repair or replace all cables and connections. c.) Switch positive and negative cables. d.) Check for short, then manually engage circuit breaker. e.) Replace Control.
2.) Lift will not operate - "LIFTGATE ACTIVATED" red LED light does not come on.	<ul style="list-style-type: none"> a.) "POWER ON" amber LED light is blinking. b.) Control not activated properly. c.) Faulty control. 	<ul style="list-style-type: none"> a.) Low voltage condition. Check and repair or replace all cables and connections. b.) Press the "LIFTGATE ACTIVATED" hidden switch twice within one second (located under the Tommy Gate logo). The red "LIFTGATE ACTIVATED" LED light should come on. c.) Replace control.
3.) Blinking amber "POWER ON" LED.	<ul style="list-style-type: none"> a.) Low voltage condition. b.) Poor grounds or connections. c.) Power connected or reconnected since last use. 	<ul style="list-style-type: none"> a.) Check and clean or repair all electrical connections. Load test battery, then recharge or replace battery, if required. b.) Repair, replace, clean as necessary. c.) Normal, press bulls-eye once to activate solid "POWER ON" amber LED.
4.) Lift will not raise or raises slowly - control working properly.	<ul style="list-style-type: none"> a.) Poor electrical connection. b.) Battery charge is low. c.) Release valve stuck partially open or dirty. d.) Release valve needs replacement. e.) "Raise" solenoid not working. f.) Safety bar switch bent- Holding release solenoid open. g.) Oil level low. h.) Vent plug not installed or dirty. i.) Overloaded liftgate. j.) Lifting roller chains improperly adjusted. 	<ul style="list-style-type: none"> a.) Check power and ground cables and all connections. b.) Recharge or replace battery. c.) Raise platform completely and continue to run pump for 5 seconds. d,e,f.) Contact Tommy Gate or distributor. g.) Check oil and add ISO grade 32, Tommy Gate winter grade hydraulic, or Dexron III/Mercon ATF. h.) Check vent plug on pump tank. A red shipping plug is installed at factory. It must be replaced by the metal vented plug. i.) Remove some material or weight. j.) Adjust Lifting roller chains.
5.) Lift settles down slowly with load or no load.	<ul style="list-style-type: none"> a.) Hoses or fittings leaking. b.) Check valve stuck or dirty. c.) Check valve damaged. d.) Cylinder seals worn or damaged. e.) Down solenoid sticking partially open. 	<ul style="list-style-type: none"> a.) Tighten or replace. b.) Raise and lower lift several times to flush out valve. c,d,e.) Contact Tommy Gate or distributor for repair or replacement.
6.) Pump or motor noisy.	<ul style="list-style-type: none"> a.) Worn pump, motor or coupling. b.) Oil level low 	<ul style="list-style-type: none"> a.) Contact Tommy Gate or distributor. b.) Check oil and add ISO grade 32, Tommy Gate winter grade hydraulic, or Dexron III/Mercon ATF.
7.) Lift lowers very slowly, especially in cold weather.	<ul style="list-style-type: none"> a.) Cold, thick, oil. b.) Sliders sticking in uprights. 	<ul style="list-style-type: none"> a.) Check oil type. Add winter grade Tommy Gate hydraulic or Dexron III/Mercon ATF. b.) Clean Sliders and Lubricate with nondetergent oil.
8.) Lift will not lower.	<ul style="list-style-type: none"> a.) Control not armed and activated - No amber "POWER ON" LED or red "LIFTGATE ACTIVATED" LED light on. b.) Poor electrical connections. c.) Sliders sticking in uprights. d.) If control working properly, damaged or non-working release solenoid. 	<ul style="list-style-type: none"> a.) Press the "POWER ON" hidden switch, marked with white rings or circles (located between the Tommy Gate logo and the toggle switch). The amber "POWER ON" LED light should come on. Now press the hidden "LIFTGATE ACTIVATED" switch twice within one second (located under the Tommy Gate logo). The red "LIFTGATE ACTIVATED" LED light should come on. b.) Check and clean or repair all electrical connections. c.) Clean sliders and lubricate with nondetergent oil. Apply downward load on platform. d.) Contact Tommy Gate or distributor.
9.) Gate does not lower smoothly.	<ul style="list-style-type: none"> a.) Lift chains need to be adjusted. b.) Installer has left a burr at bottom of uprights. c.) Load has been put off to one side of platform. d.) Platform drop chains improperly adjusted. 	<ul style="list-style-type: none"> a.) Adjust lift chains so platform is level with top of mainframe on both driver's and passenger's side. b.) Raise and close platform, grind or file off burr from outrail. c.) Center load on the platform. d.) Adjust platform drop chains.
10.) Gate lowers when trying to raise.	<ul style="list-style-type: none"> a.) Safety trip bar damaged. b.) Safety switch bent or stuck open. 	<ul style="list-style-type: none"> a.) Straighten or replace safety bar. b.) Check switches for free movement up and down.



STANDARD WARRANTY

Railgate Series 1600 & 2000

The Tommy Gate Company provides a limited warranty against faulty materials or workmanship.

2-Year Warranty

Tommy Gate pump and motor unit parts are guaranteed for two (2) full years from date of user purchase against faulty materials or workmanship.

1-Year Warranty

Tommy Gate Railgates are guaranteed for (1) year from the date of user purchase against faulty materials or workmanship.

All affected parts must be returned to the factory prepaid - with full credit issued for those found to be defective. Warranty replacement parts will be shipped from the factory prepaid.

Labor charges to install warranty replacement parts shall be paid in accordance with Tommy Gate's estimated repair time guide and a flat hourly rate established by Tommy Gate.

DEVIATION FROM THE WARRANTY TIMES LISTED MUST BE AUTHORIZED BY TOMMY GATE COMPANY IN ADVANCE.

The warranty does not include damage resulting from improper installation procedures. Parts must be installed according to Tommy Gate Company's specifications.

Tommy Gate Company will not pay labor for removing other equipment to gain access to Tommy Gate Equipment. Tommy Gate Company will not pay labor for time on the road to and from a service call.

Tommy Gate Company reserves the right to disallow or reduce claims for parts which have been damaged due to misuse, abuse, accidents, improper shipping; or parts which have been incorrectly or unnecessarily replaced.

The warranty is void if the product has been subject to other than normal use. **THERE ARE NO WARRANTIES, EXPRESS OR IMPLIED, INCLUDING THE WARRANTY OF MERCHANTABILITY OR A WARRANTY OF FITNESS FOR A PARTICULAR PURPOSE EXTENDING BEYOND THAT SET FORTH ABOVE.**

NOTE: SEE FOLLOWING PAGE FOR THE WARRANTY CLAIMS HANDLING PROCEDURE.



WARRANTY CLAIMS HANDLING PROCEDURE

The following procedures are required when an authorized distributor submits a warranty claim for a defective Tommy Gate part:

1. Before any expense is incurred, but after the problem has been diagnosed, the authorized distributor should contact Tommy Gate Company's Warranty Department to discuss the problem and its correction.
2. If it is determined that the condition is potentially covered by Tommy Gate Company's warranty, the authorized distributor will receive instructions on how to proceed. A decision will be made to either repair or replace the product or part in question.
3. If the product or parts are to be repaired, the authorized distributor will receive a **WARRANTY REQUEST NUMBER**.
4. If the product or parts are to be replaced, the authorized distributor will be instructed to either hold the parts for inspection by a representative, in which case the authorized distributor will receive a **WARRANTY REQUEST NUMBER**, or the authorized distributor will be asked to return the product for inspection to Tommy Gate Company, in which case the authorized distributor will receive a **RETURN GOODS AUTHORIZATION NUMBER**. Under no circumstances are parts to be returned without a **RETURN GOODS AUTHORIZATION NUMBER**.
5. After the repair or replacement work is completed, the authorized distributor will submit the claim to Tommy Gate Company with the following information.
 - a. Tommy Gate Company **WARRANTY REQUEST** and/or **RETURN GOODS AUTHORIZATION NUMBER**.
 - b. Tommy Gate model number.
 - c. Tommy Gate serial number.
 - d. Tommy Gate part number involved and a description of the apparent problem or defect.
 - e. Authorized distributor performing warranty work.
 - f. Person responsible for warranty work (contact).
 - g. Distributor from whom lift gate was purchased.
 - h. Lift gate owner's name, address, and phone number.
 - i. Action taken, cost involved, complete with work orders and parts expense invoices.
6. If defective parts are to be returned to Tommy Gate Company they:
 - a. Must be packaged for each individual warranty return. No multiple warranty claims in the same box.
 - b. Must be returned "freight prepaid" to Tommy Gate Company's location.
 - c. Must be clearly marked with the **RETURN GOODS AUTHORIZATION NUMBER** on the outside of the package.

Warranty claims must be submitted by the Authorized Distributor on behalf of their customer as part of their customer assistance.

Warranty claim acceptance or rejection is based solely upon defective part inspection and a review of the claim data (outlined in step 5 above) as they apply to the requirements of Tommy Gate Warranty. Claim reimbursement after acceptance is governed by those allowances previously agreed upon between Tommy Gate Company and the Authorized Distributor (as outlined in Steps 1-4 above).

Any warranty claims submitted without a **WARRANTY REQUEST NUMBER** or **RETURN GOODS AUTHORIZATION NUMBER** and the necessary information will be denied.

1600 AND 2000 RAILGATE SERIES REPAIR PARTS DRAWING

FOR MODELS 73, 79, 85, 89 & 95
(WITH INTERNAL TIMED ELECTRIC TOGGLE CONTROL)

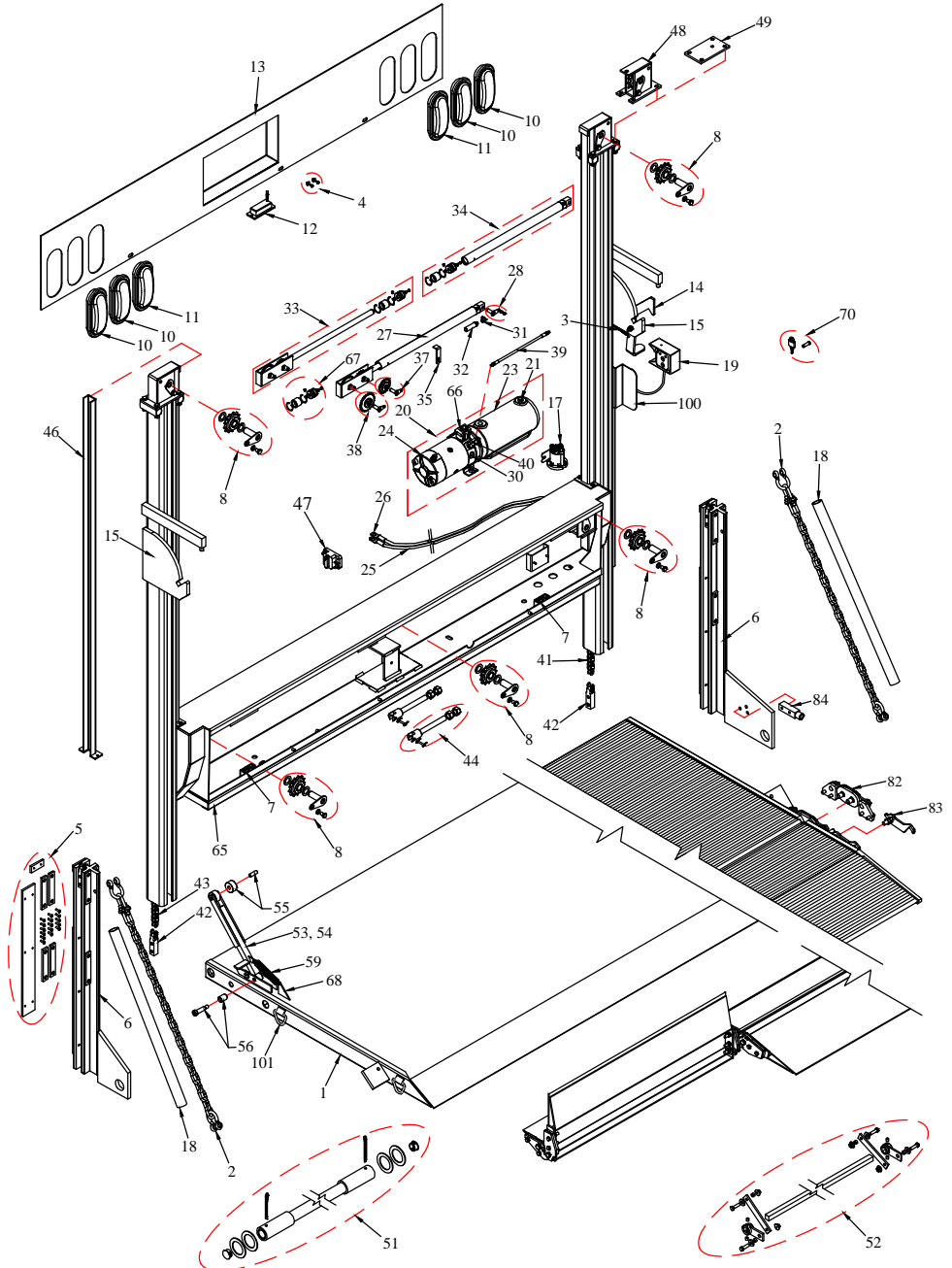

1600 AND 2000 RAILGATE SERIES BOTTLE RACK REPAIR PARTS DRAWING

FOR MODELS 73, 79, 85, 89 & 95
(WITH INTERNAL TIMED ELECTRIC TOGGLE CONTROL)

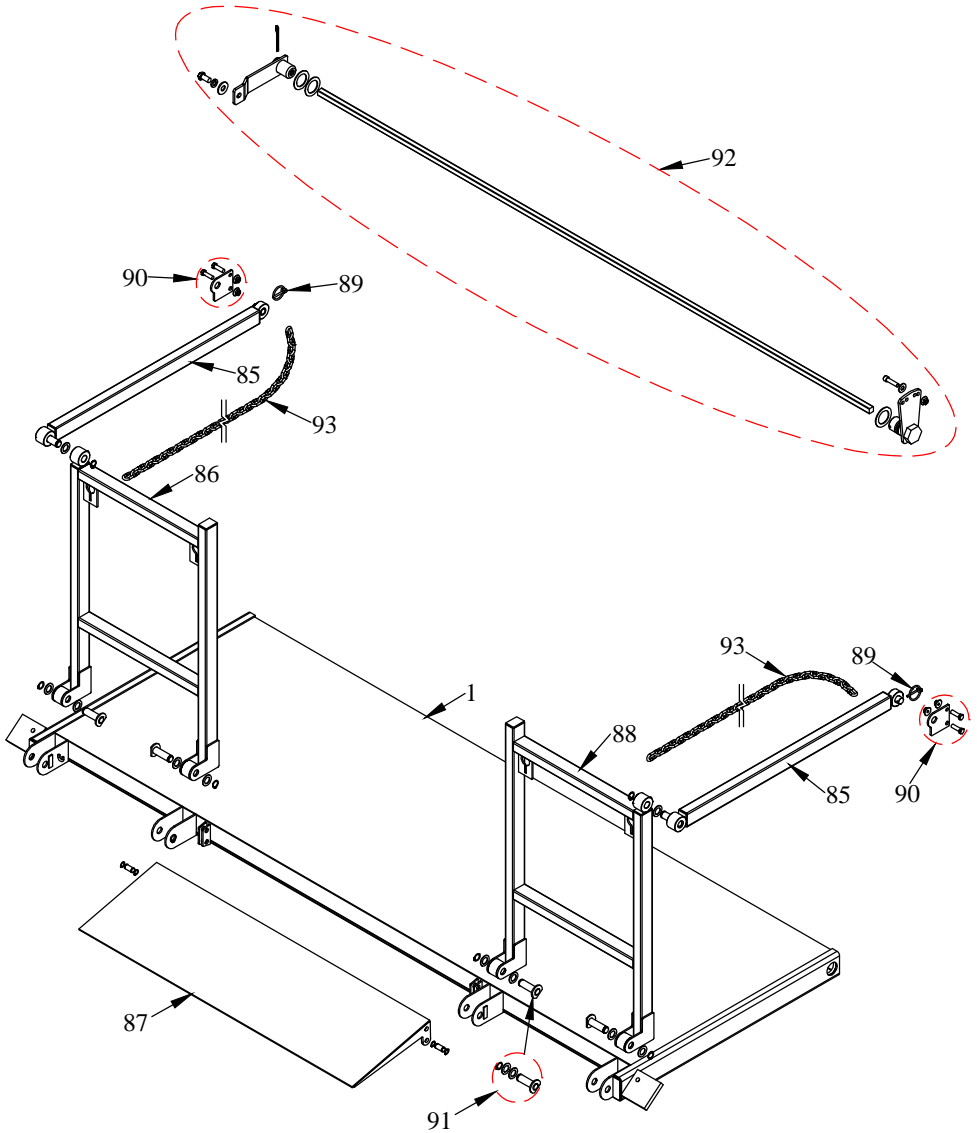

1600 AND 2000 RAILGATE SERIES ALUMINUM CARTSTOP REPAIR PARTS DRAWING

FOR MODELS 73, 79, 85, 89 & 95
(WITH INTERNAL TIMED ELECTRIC TOGGLE CONTROL)

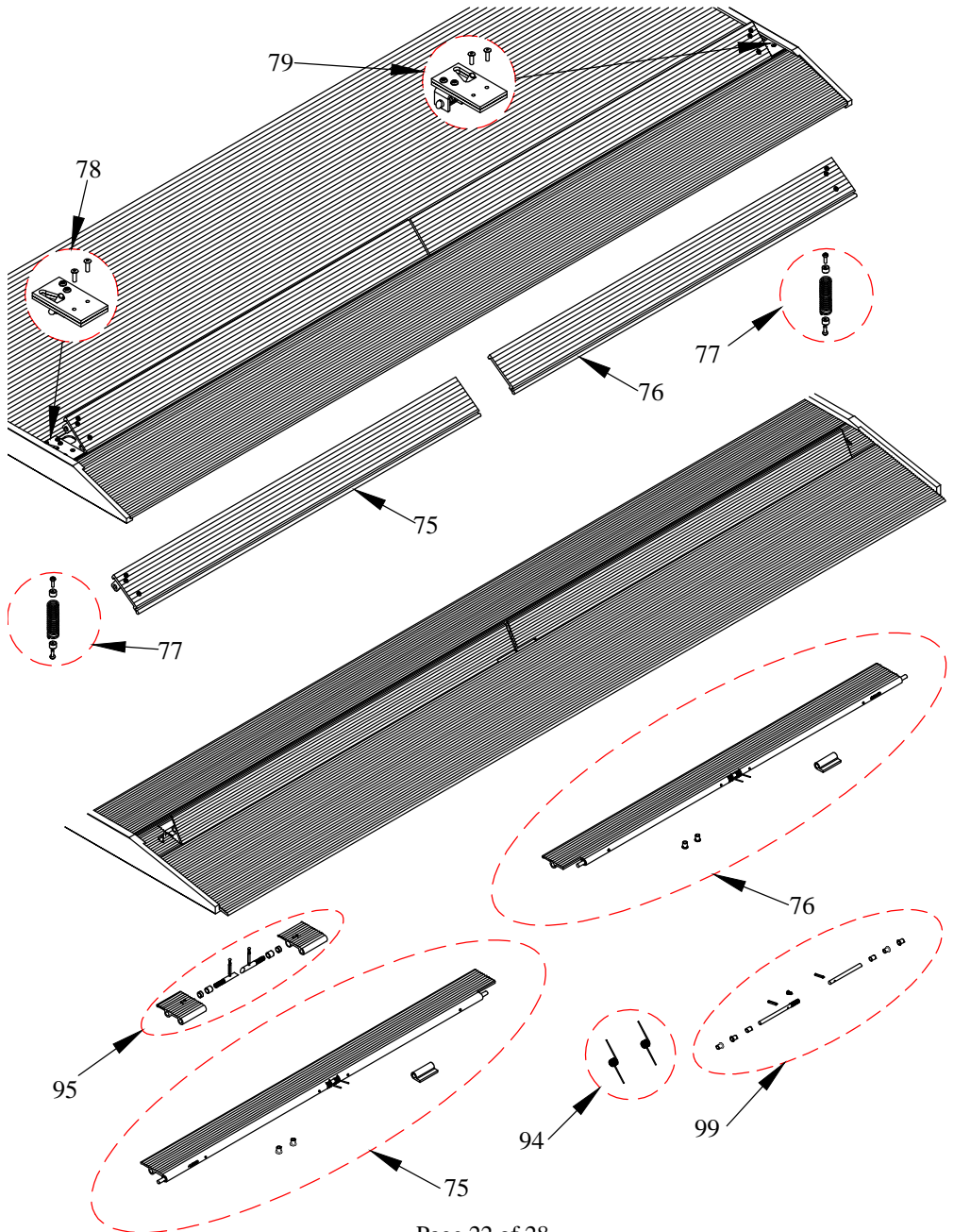

1600 AND 2000 RAILGATE SERIES REPAIR PARTS LIST

FOR MODELS 73, 79, 85, 89 & 95
(WITH INTERNAL TIMED ELECTRIC TOGGLE CONTROL)

ITEM#	DESCRIPTION	ITEM#	DESCRIPTION
1	Platform	46	Roller Chain Cover- Above Bed only
2	Platform Chains	47	150 Amp Manual Reset Circuit Breaker
3	Railgate Latch Spring	48	Upright Cap-Above Bed Only
4	License Plate Mount Kit	49	Upright Cap-Bed Height Only
5	Bearing Pad Set	51	Hinge Tube
6	Slider	52	Self-Close Rod and Linkage
7	Safety Switch	53	Self-Close Arm-Left
8	13 Tooth Sprocket	54	Self-Close Arm-Right
10	Red Light	55	Self-Close Roller
11	Clear Light	56	Self-Close Arm Bushing
12	License Plate Light	59	Extension Spring
13	Box Cover w/Lights	65	Safety Trip Bar
14	Latch Lever	66	Release Solenoid
15	Latch Plate	67	Cylinder Repair Kit
17	Raise Solenoid	68	Platform Triangle Deadman
18	Cloth Chain Cover	70	Latch Padlock and Pin
19	Timed Control	75	Left Cartstop Assembly
20	Pump & Motor	76	Right Cartstop Assembly
21	Vent Plug	77	Cartstop Spring Assembly
23	Tank	78	Left Cartstop Latch
24	Motor-Only	79	Right Cartstop Latch
25	4ga. 2 Wire Electric Cable	82	Platform Gear Kit-RF Only
26	Copper Lug	83	Platform Latch-RF Only
27	Cylinder	84	Platform Stop Block-RF Only
28	Cylinder Pin	85	Bottle Rack Horizontal Tube
30	Lee Check Valve	86	Bottle Rack Fence-Left
31	Steel Cylinder Elbow	87	Bottle Rack Taper
32	Flow Control	88	Bottle Rack Fence-Right
33	Cylinder Shaft	89	Bottle Rack Lynch Pin
34	Cylinder Barrel	90	Bottle Rack Pivot Plate
35	Cylinder Clamp	91	Pivot Pin
37	19 Tooth Sprocket	92	Square Torsion Spring
38	25 Tooth Sprocket	93	Bottle Rack Chain
39	Hydraulic Hose	94	Cartstop Torsion Springs
40	90 Degree Pump Elbow	95	Cartstop Latch Kit
41	Roller Chain-Passenger's Side	99	Cartstop Hinge Kit
42	Roller Chain Attachment Fitting	100	CTC Mounting Bracket and Shield Kit
43	Roller Chain- Driver's Side	101	Tie Down Ring
44	Adjustment Screw, Clevis & Pin		

Note:

The item number **is not** the part number. Please have the model number and serial number available before calling for repair parts.

THIS PAGE
INTENTIONALLY LEFT
BLANK

THIS PAGE
INTENTIONALLY LEFT
BLANK

THIS PAGE
INTENTIONALLY LEFT
BLANK

SERVICE RECORD

LIFTGATE INFORMATION

Date of Purchase: _____

Serial Number: _____

Installed By: _____

Model Number: _____

Reminders: Service liftgate according to page 16.

Date of Service

Services Performed



**America's First Name
in Liftgates™**

**Manufacturing Plant:
83 Bus Brown Drive
Woodbine, Iowa 51579
FAX (712) 647-2417**

**Corporate Offices:
33717 N. Scottsdale Rd. Ste 120
Scottsdale, AZ 85266
FAX (602) 955-3902**

**(712) 847-8000
www.tommygate.com**

